

EN Troll Comfort / Troll Comfort 3D

Instruction manual for the electrical connection and for commissioning

Item no. Troll Comfort / Troll Comfort 3D
3650 00 12 / 3650 07 12 (ultra-white)
3650 05 22 / 3650 07 22 (aluminium)

Type: 5625-UW, 5625-AL / 5635-UW, 5635-AL



1.	This manual.....	5
1.1	How to use this manual	5
2.	Hazard symbols.....	6
2.1	Levels of danger and signal words.....	6
2.2	Symbols and depictions used.....	7
3.	Safety instructions.....	8
3.1	Intended use	9
3.2	Improper use.....	10
3.3	Expert knowledge required by the installer	10
3.4	Glossary - definition	11
4.	Included in delivery.....	12
5.	General view of the operating unit	13
5.1	General view of the installation housing.....	15
5.2	Electrical connections.....	16
5.3	Display and its symbols.....	17
6.	Product description.....	19
6.1	Description of the safety functions.....	20
6.2	Overview of functions	21
7.	Technical specifications	23
7.1	Factory settings.....	25
7.2	Conduct in the event of a power failure	27
8.	Safety instructions for the electrical connection.....	28
8.1	Important information prior to the electrical connection and installation.....	30
8.2	Electrical connection.....	32
8.3	Connecting a tubular motor to the Troll Comfort	33
8.4	Connecting a lamp to the Troll Comfort *	34
8.5	Connecting a tubular motor to the Troll Comfort 3D.....	35
9.	Installation after the electrical connection.....	36
10.	Brief description of the standard display and main menu	37

11. Introduction to opening the menus and setting the functions	38
12. Initial commissioning with the help of the installation wizard	40
13. Manual operation	43
14. Moving to a target position	44
15. Menu overview	45
16. Menu 1 - Switching automatic mode on/off	47
17. Switching times (opening and closing times) [▲/▼], brief description	48
17.1 Menu 2 - Configuring opening and closing times [▲/▼] ...	52
18. Connecting a local light sensor	56
18.1 Light sensor connection when using the supplied frame	57
18.2 Light sensor connection when using a frame supplied by other manufacturers	58
18.3 Dismantling the light sensor	60
19. Automatic dusk function, brief description	61
19.1 Menu 3 - Customising the automatic dusk function	63
20. Automatic sun function, brief description	65
20.1 Menu 4 - Configuring the automatic sun function	67
21. Automatic dawn function, brief description	69
21.1 Menu 5 - Customising the automatic dawn time	70
22. Menu 6 - Configuring the random function	71
23. Automatic wind function, brief description	72
23.1 Menu 7 - Configuring the automatic wind function	73
24. Automatic rain function, brief description	74
24.1 Menu 8 - Configuring the automatic rain function	75

25. Menu 9 - System settings	76
25.1 Menu 9.1 - Setting the time and date	77
25.2 Menu 9.2 - Configuring the motor run time.....	78
25.3 Menu 9.3 - Configuring the ventilation position	80
25.4 Menu 9.4 - Setting the postcode	82
25.5 Menu 9.5 - Configuring the switching time programme....	83
25.6 Menu 9.6 - Configuring the blockage detection.....	85
25.7 Menu 9.7 - Setting the Venetian blind mode	88
26. Menu 9.8 - Device settings	90
26.1 Menu 9.8.1 - Switching the automatic summer/ winter time on/off	91
26.2 Menu 9.8.2 - Setting the display contrast.....	92
26.3 Menu 9.8.3 - Setting the permanent display lighting	92
26.4 Menu 9.8.3 - Setting the timer mode	93
26.5 Menu 9.8.5 - Switching the button lock on / off.....	94
26.6 Menu 9.8.6 - Configuring the inputs E1/E2.....	95
26.7 Menu 9.8.7- Switching the reversal of rotation direction on/off	97
26.8 Menu 9.8.8 - Configuring the light function.....	98
26.9 Menu 9.8.9 - Configuring the end points of the tubular motor	101
26.10 Menu 9.8.0 - Displaying the software version.....	103
27. Deleting all settings, software reset.....	104
28. Performing a hardware reset.....	105
29. Error messages	106
30. Dismantling	106
31. Time zone table.....	107
32. Simplified EU declaration of conformity	109
33. Accessories.....	109
34. Warranty terms and conditions	110



1. This manual...

EN

...describes how to install, connect the electrical system and operate the Troll Comfort and the Troll Comfort 3D.



1.1 How to use this manual

- ◆ Before you begin, please read this manual through completely and follow all the safety instructions.
- ◆ Please also read the instruction manuals for the accessories (if available) as well as the manuals for the respective connected electrical appliances.
- ◆ This manual is part of the product. Please store it in an easily accessible place.
- ◆ When passing the Troll Comfort or Troll Comfort 3D on to a third party, this manual must be passed on as well.
- ◆ Damage resulting from non-compliance with this manual and the safety instructions will void the warranty. We assume no liability for any resulting damage.



2. Hazard symbols

EN

The following hazard symbols are used in this manual:



Danger to life resulting from electric shock



Danger area / dangerous situation



2.1 Levels of danger and signal words

 **DANGER!**

This hazard will lead to serious injury or death if not avoided.

 **WARNING!**

This hazard may result in serious injury or death if not avoided.

 **CAUTION!**

This hazard may result in minor or moderate injury if not avoided.

 **ATTENTION!**

This hazard may lead to property damage.



Other useful information



Please read the respective manual

1. Procedures

2.

◆ Itemisation

1) or a) Lists



Activated menu symbols and setting parameters flash on the display.

Information about opening the menus and setting the parameters can be found on page 38.



The wind or rain symbol is only displayed in the main menu if an external input (**E1 or E2**) is configured for the automatic wind or rain function.



Danger due to electric shock when working on all electrical systems.

- ◆ The electrical connection and all work on electrical systems must only be carried out by a qualified electrician in accordance with the connection instructions in this manual.
- ◆ Carry out all installation and connection work only in a de-energised state.



The use of defective devices can lead to personal injury and property damage (electric shocks / short circuiting).

- ◆ Never use defective or damaged devices.
- ◆ Check the Troll Comfort or Troll Comfort 3D for damage.
- ◆ Please contact our Customer Service if you find any damage, see page 112.

Improper use leads to an increased risk of injury.



- ◆ Train all personnel to use the Troll Comfort or Troll Comfort 3D safely.
- ◆ Children must not play with the device.
- ◆ Never remove the operating unit from the installation housing during operation.

Use the Troll Comfort or Troll Comfort 3D exclusively as follows.

Application:	Troll Comfort	Troll Comfort 3D
Connection and control of a tubular motor for: <ul style="list-style-type: none"> ◆ Roller shutters and awnings ◆ Venetian blinds and slats 	✓	✓
Connection and control of an electrical appliance	✓	—
Electrical connection is possible without neutral terminals	—	✓

Observe the permissible load limits, see page 23, Technical specifications.

Operating conditions

- ◆ The tubular motor must be fitted with a mechanical or electronic end position switch.
- ◆ Only operate the Troll Comfort or Troll Comfort 3D in dry rooms
- ◆ A 230 V/50 Hz power supply, together with a site-provided disconnecting device (fuse), must be available at the installation location.
- ◆ **Troll Comfort 3D**

The Troll Comfort 3D can only be operated in combination with tubular motors with mechanical limit switches and with Rademacher tubular motors with electronic limit switches from the year 2000 onwards.

Using the Troll Comfort or Troll Comfort 3D for purposes other than those previously mentioned is not permissible.



Personal injury and property damage may occur if the Troll Comfort is used to disconnect the connected appliance.

- ◆ Do not use the Troll Comfort to disconnect the connected appliance.



There is a risk of fatal injury caused by short circuiting and electric shocks if the Troll Comfort or Troll Comfort 3D is used outside or in damp rooms.

Do not install and use the Troll Comfort or Troll Comfort 3D outside or in damp rooms.

The electrical connection, installation and commissioning of the Troll Comfort and Troll Comfort 3D must only be carried out by a qualified electrician in accordance with the instructions in this manual.

UW

- ◆ UW = ultra-white (device colour)

DIN 49075

- ◆ German Standard "Cover panels for installation devices for building into device boxes..."

ELV

- ◆ Extra low voltage

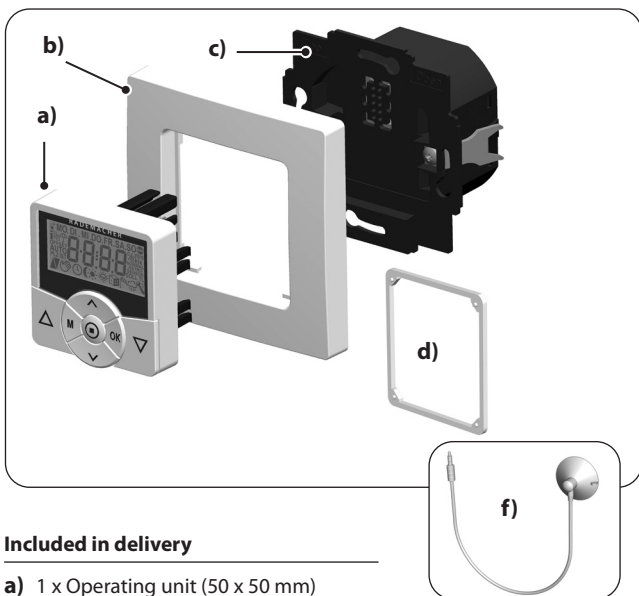

Included in delivery

- a) 1 x Operating unit (50 x 50 mm)
- b) 1 x Frame
- c) 1 x Installation housing
- d) 1 x Spacer frame, see page 36
- e) 1 x Instruction manual (not illustrated)



After unpacking please check and compare...



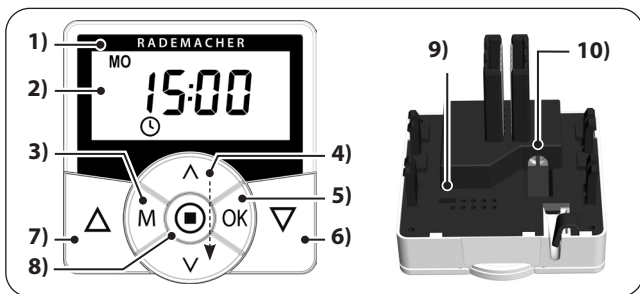

... the contents of the package with those specified above.

Accessories optionally available, see page 109

- f) 1 x Light sensor



Pos.	Symbol	Description
1)		Operating unit
2)		Display
3)		Menu button <ul style="list-style-type: none"> ◆ Open the main menu ◆ Back to the previous menu or standard display
4)	 	Setting buttons <ul style="list-style-type: none"> ◆ Select a menu in the main menu ◆ Set the parameters (more / less) <ul style="list-style-type: none"> ● Short press or press and hold = gradual or quick setting ◆ Switch functions on / off (On / OFF) ◆ Move to a target position

Pos.	Symbol	Description
5)		OK button <ul style="list-style-type: none">◆ <i>Open the selected menu</i>◆ <i>Confirm and save settings</i>◆ <i>Continue to the next setting</i>
6)		Operating buttons Up / Down <ul style="list-style-type: none">◆ <i>Manual operation</i>
7)		
8)		SET/Stop button <ul style="list-style-type: none">◆ <i>Manual stop of the roller shutter travel</i>◆ <i>Set (adjust) various functions</i>
9)		Bridging contact for a hardware reset <ul style="list-style-type: none">◆ <i>See page 105</i>
10)		Connection socket for the light sensor <ul style="list-style-type: none">◆ <i>See page 57, Installation</i>

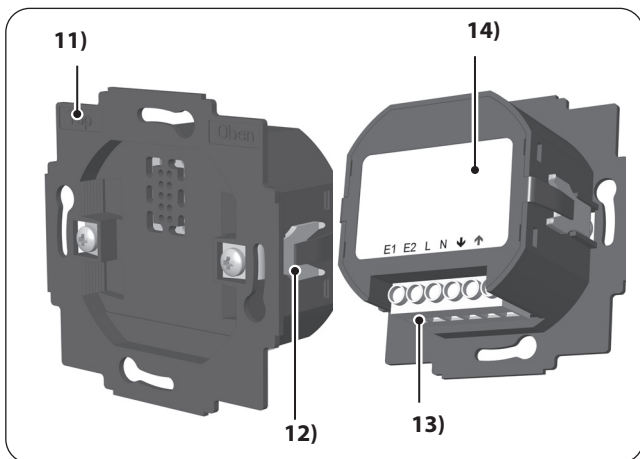



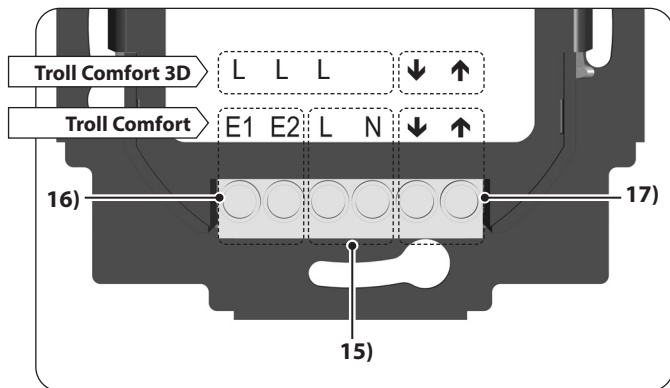



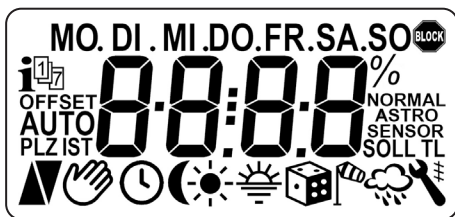

Pos.	Symbol	Description
11)		Installation housing
12)		Claw fasteners and screws
13)		Connecting terminals
14)		Type plate (example for the Troll Comfort)



Pos.	Symbol	Description
15) /	L	Troll Comfort 3D
16)		Power supply - 230 V / 50 Hz ~ <i>Electrical connection is possible without neutral terminals.</i>
15)	L / N	Troll Comfort Power supply - 230 V / 50 Hz, 60 Hz ~
16)	E1 / E2	Troll Comfort - external inputs - optional <i>Connect external signal transmitters, e.g. Venetian blind switches/external sensors etc., see page 33 / 34.</i> <i>Both inputs are independently configured, see page 95.</i>
17)	↓ / ↑	Rotation direction (up / down) <i>Connecting cables to the tubular motor.</i>



Symbol	Description
MO ... SO	Weekdays (Monday ... Sunday)
88:88	Time / setting parameters
i	Information
1 7	Switching time programme
OFFSET	Offset (for astro time)
SET	Setting
AUTO	Automatic mode
PLZ	Postcode
IST	Actual value
▼	Direction of travel (up/down)
☞	Automatic mode off
🕒	Switching times
☾	Automatic dusk function

Symbol	Description
	Automatic sun function
	Automatic dawn function
	Random function
	Automatic wind function *
	Automatic rain function *
	System settings
SOLL	Set value
	Automatic slat adjustment
T	Jog mode
L	Light function *
NORMAL	Switching modes (NORMAL / ASTRO / SENSOR)
	Blockage detection *
%	Position (in percent)
	Automatic button lock

* not available for the **Troll Comfort 3D**

The Troll Comfort and Troll Comfort 3D are designed for controlling roller shutters, Venetian blinds, slats or awnings by connecting a corresponding tubular motor.

Roller shutter control

The device enables the roller shutter to be automated.

Manual operation

It is possible to manually control the connected tubular motor at any time by using the controls.

Troll Comfort (not for the Troll Comfort 3D)...

◆ with a light function

If required, you can connect a lamp, for example, or other electrical appliances to the Troll Comfort instead of a tubular motor and use the light function to control it.

◆ as a central controller for several Troll Standard controllers

The Troll Comfort can also be used as a central controller for several Troll Standard controllers, as an alternative to connecting a tubular motor. You can obtain additional connection and circuit examples from our website: www.rademacher.de

◆ with an external controller via the two inputs E1 and E2

The Troll Comfort has two configurable inputs E1 and E2 (230 V / 50 Hz) for connecting external signal transducers (e.g. Venetian blind switches / external sensors etc.), see page 33 / 34.

Both inputs are independently configured, see page 95.

Installation and electrical connection

The Troll Comfort and Troll Comfort 3D are designed as a flush-mounted device for indoor rooms. The electrical connection is carried out by means of the connecting terminals on the reverse side of the installation housing.

Installation / compatible switch ranges

The Troll Comfort and Troll Comfort 3D can be integrated into standard switch ranges (50 x 50 mm).



It may be necessary to use an intermediate frame * 50 x 50 (according to DIN 49075) depending on the switch range used.

** Not included*

6.1 Description of the safety functions

Troll Comfort with blockage detection *

The Troll Comfort is able to monitor the torque of motors equipped with a mechanical end point setting. This enables the controller to switch off the motor in the event of overloading or blockage, see page 85.

** not available for the **Troll Comfort 3D***

- ◆ Display background lighting
- ◆ Installation wizard for easy commissioning
- ◆ Configurable blockage detection for mechanical tubular motors
- ◆ Manual operation on site
- ◆ Direct configuration and movement to a target position
- ◆ Switch automatic mode on/off
- ◆ Easy configuration with menu-driven operation
- ◆ Switching times
 - Configurable opening [▲] and closing times [▼] for your roller shutter
- ◆ Switching time programme:
 - Weekly switching times
 - One switching time pair [▲/▼] for [MO...SO] (MON...SUN)
 - Weekday and weekend switching times
 - One switching time pair [▲/▼] for [MO...FR] (MON...FRI)
 - One switching time pair [▲/▼] for [SA + SO] (SAT + SUN)
 - Individual day switching times
 - One switching time pair [▲/▼] for every day of the week [MO / DI / MI / DO / FR / SA / SO] (MON / TUE / WED / THU / FRI / SAT / SUN)
 - Activate a second switching time block
 - Double switching times, see page 48 / 84
- ◆ Automatic dusk function
 - Automatic dusk function with astro programme
 - Automatic dusk function with light sensor
- ◆ Automatic sun function (with light sensor)
- ◆ Automatic dawn function with astro programme
- ◆ Random function (random delay of 0 to 30 minutes)
- ◆ Ventilation position

- ◆ End point setting *
- ◆ Button lock
- ◆ Venetian blind mode
 - Automatic slat adjustment
 - Jog mode
 - Set the run time
- ◆ Automatic wind function *
- ◆ Automatic rain function *
- ◆ Light function (controlling electrical appliances) *
- ◆ Switch reversal of rotation direction on/off
- ◆ Automatic summer / winter changeover
- ◆ Permanent storage of the settings
- ◆ External control via the two configurable inputs E1 / E2 *
- ◆ Delete or reset all data

** not available for the **Troll Comfort 3D***

Description and configuration of the individual functions

A precise description of the individual functions and settings is included starting on page 37.

Troll Comfort**Mains connection [L / N]**

Mains supply voltage:	230 V / 50 Hz, 60 Hz ~
Consumption:	Standby: < 0.3 W

2 x extension inputs [E1 / E2] - configurable

Connection of external signal transducers (Venetian blind button/ environmental sensor etc.)

Input voltage:	230 V / 50 Hz ~ (Ri = 200 kΩ)
Maximum cable length:	15 metres

Rotation direction [▲ / ▼]

Switching voltage:	230 V / 50 Hz ~	
Switching capacity:		8 (4) A μ (Type 1B)



Personal injury and property damage may occur if the Troll Comfort is used to disconnect the connected appliance.

- ◆ Small contact distance (μ), not suitable for disconnecting the device.
- ◆ Do not use the Troll Comfort to disconnect the connected appliance.

Troll Comfort 3D**Mains connection [L]**

Mains supply voltage:	230 V / 50 Hz ~
Consumption:	Standby: < 0.3 W

Rotation direction [▲ / ▼]

Switching voltage:	230 V / 50 Hz ~		
Switching capacity:	<table border="1" style="display: inline-table; vertical-align: middle;"> <tr> <td style="text-align: center; width: 40px; height: 40px;">M</td> <td style="padding: 0 10px;">8 (4) A μ (Type 1B)</td> </tr> </table>	M	8 (4) A μ (Type 1B)
M	8 (4) A μ (Type 1B)		

Troll Comfort / Troll Comfort 3D**General information**

External dimensions (W x H x D)	50 x 50 x 12 mm
Operating unit [1]:	according to DIN 49075
Available colours:	Ultra-white (UW), glossy Aluminium
Installation depth:	32 mm
Permissible ambient temperature:	0 °C to + 40 °C
Protection class:	II (<i>only for use in dry rooms</i>)
Connecting terminals:	Screw terminals for max. 1.5 mm ² cable cross-section
Power reserve for the timer in the event of a power failure	Approx. 8 hours

Factory settings	
Automatic mode:	On
Switching times:	On
Date:	01.07.2018
Time:	12:00
Up-time and mode:	7:00 / NORMAL
Down-time and mode:	20:00 / NORMAL
Random function:	OFF
Automatic sun function:	OFF
Motor run time (2 - 255 sec.):	150 seconds
Ventilation position (1 - 99 %):	OFF / 80 %
Postcode:	34
Switching time programme:	1
Blockage detection: *	OFF
- Motor type:	2 (45 mm / 30 Nm)
- Sensitivity:	2:30
- Reversing function:	OFF
Jog mode:	OFF
Automatic slat adjustment:	OFF
Tilting time / slat runtime: 100 - 5000 ms (0.1 to 5 sec.)	1.5 seconds (1500 ms)
Automatic summer / winter change-over:	On

* not available for the **Troll Comfort 3D**

Factory settings	
Display contrast:	8
Display backlighting:	0
Timer mode: *	1 (50 Hz)
Button lock:	OFF
Inputs E1 / E2: *	OFF / OFF
Reversal of direction of rotation:	OFF
Light function: *	OFF

* not available for the **Troll Comfort 3D**

Power reserve (approx. 8 hours)

The current time flashes for approx. 5 minutes in the event of a power failure and the Troll Comfort or Troll Comfort 3D changes to power reserve.

Time and date after a power failure

The power reserve is approx. 8 hours. If this time is exceeded, the time and date are lost and need to be reset, see page 77.



The internal timer works with tolerances in power reserve mode. It may therefore be necessary to adjust the time after a longer power failure.

Data retention following a power failure

All settings remain permanently saved. Data is not lost even after a longer power failure.

Prior to the electrical connection, check that the voltage / frequency on the type plate corresponds to that of the local mains supply.



Follow the electrical connection specifications in the instruction manual of the tubular motor being used or that of the electrical appliance and external controller (when using E1/E2).

 **DANGER!**

There is a risk of fatal electric shock when touching electrical components.

- ◆ All connection and installation work must only be carried out in a de-energised state.
- ◆ Disconnect all phases of the mains power lead and secure it to prevent any reconnection.
- ◆ Check that the system is de-energised.

 **WARNING!**

Overloading of the Troll Comfort can lead to personal injury and destruction of the device (short circuiting).

The maximum switching capacity must not be exceeded; please observe the details in the technical specifications, see page 23.

 **WARNING!**

Using an incorrect installation housing can lead to personal injury and property damage (electric shocks / short circuiting).

- ◆ Only use the installation housing provided to connect and install the Troll Comfort or Troll Comfort 3D.
- ◆ Installation housings of other RADEMACHER products, such as other Troll controllers, are not compatible.

 **WARNING!**

Connection of a second phase to E1 or E2 will cause the Troll Comfort to be damaged.

- ◆ When using the inputs [E1 / E2], they must always be connected to the same phase [L] as the supply voltage.
- ◆ If another phase is connected, the **incorrect mains voltage (380 V / 50 Hz)** will be applied to the inputs and damage the Troll Comfort.
- ◆ Follow the pin assignment detailed in the connection diagram.

Setting the end points on the tubular motor



You must configure the end points of the tubular motor before installing it and making the final electrical connection otherwise malfunctions may occur.

It is essential that you set both end points of the tubular motor if no end points have been set yet.

Parallel connection of electronic tubular motors

A maximum of 3 tubular motors can be connected in parallel to the Troll Comfort or Troll Comfort 3D (e.g. RADEMACHER electronic tubular motors).



In order to do so, follow the information in the instruction manual of the tubular motor being used.

Parallel connection of mechanical tubular motors

A cut-off relay is required in order to connect mechanical tubular motors in parallel.

Requirements for blockage detection *

Blockage detection is only operational if a mechanical tubular motor is connected.

Function of inputs E1 and E2 *

Both inputs can be configured independently of each other. You can configure the functions of the inputs in menu 9.8.6, depending on the required purpose of the connected signal transducers, see page 95.

You can obtain connection and circuit examples from our website at www.rademacher.de

** not available for the **Troll Comfort 3D***

Maximum cable length for connecting external signal transducers to E1 or E2 (e.g. Venetian blind buttons/ external sensors etc.)

The maximum cable length for connecting external signal transducers to E1 or E2 must be 15 metres.

Installation materials

The Troll Comfort and Troll Comfort 3D are designed for flush-mounted installation. We recommend installation in a deep 58 mm flush-mounted box or in an electronic socket.

Stripping length

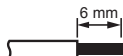

All wires must be stripped to 6 mm.

1. Ensure the mains power is disconnected and check whether the leads are current-free.
2. Securely lay all connecting cables right into the flush-mounted box.
3. Remove the insulation on all wires down to 6 mm in length and connect them according to the connection diagram on the following pages.
4. After the electrical connection, the installation of the Troll Comfort or Troll Comfort 3D into the flush-mounted box is carried out, see page 36.

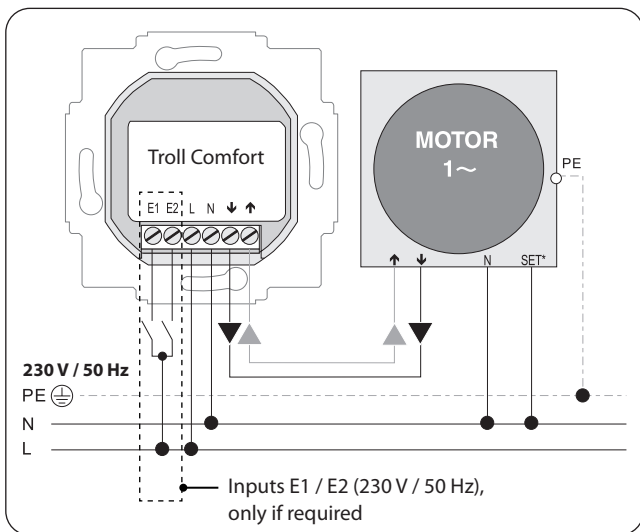

Connecting the set cord (SET) from RADEMACHER electronic tubular motors

- * The set cord (**SET**) from RADEMACHER tubular motors must be connected to the neutral terminal [**N**] to ensure trouble-free operation of the tubular motor.

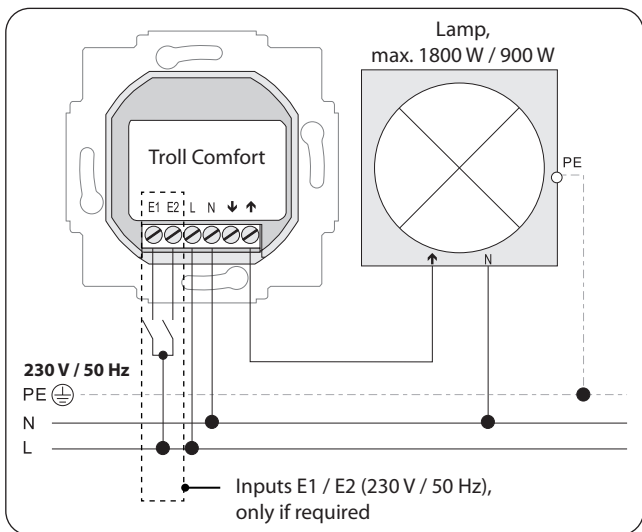

If required, you can connect a garden light (or other electrical appliances) to the controller instead of a tubular motor and use the light function to control it, see page 98, Menu **9.8.8 - Setting the light function**.

Maximum switching capacity

The maximum switching capacity is 1800 W or 900 W (for non-resistive loads).

* not available for the **Troll Comfort 3D**.



8.5 Connecting a tubular motor to the Troll Comfort 3D

EN

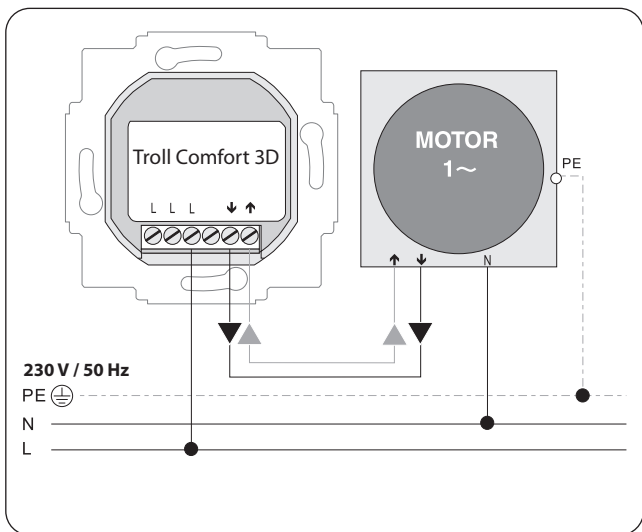

No neutral terminals are required

No neutral terminal is required when connecting a Troll Comfort 3D. This means that a manual switch can be replaced by a Troll Comfort 3D without having to subsequently install a neutral terminal.



The electrical connection of the Troll Comfort is described on page 33.

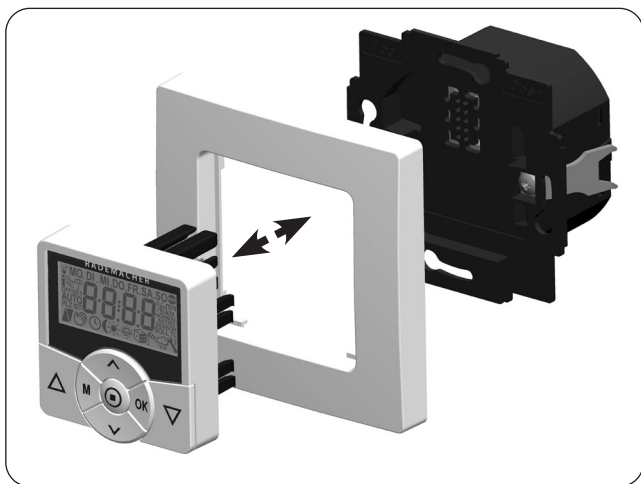

1. Insert the installation housing into the flush-mounted box and fasten it with the screws of the claw fasteners.
2. Place the frame onto the installation housing.
3. Then carefully insert the operating unit into the installation housing .
4. Switch on the mains power supply again.

The standard display (example)

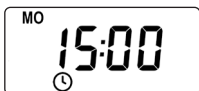

- ◆ Displays the current day of the week and time.
- ◆ Displays the activated functions.
- ◆ Manual operation of the Troll Comfort or Troll Comfort 3D is only possible from the standard display.

Main menu



Menu number

Functions / menus

- ◆ Enables display and selection of the individual functions and menus.
- ◆ Manual operation is not possible from the main menu.
- ◆ No automatic switching commands will be executed during the configuration process.
- ◆ If no button is pressed within approx. 120 seconds, the display automatically changes from the active menu back to the standard display. Changes to settings are nevertheless saved.



11. Introduction to opening the menus and setting the functions

EN

1. **M**

Open the main menu.



Pressing the menu button on the standard display opens the main menu.

2. **^** / **v**

Select the desired menu or menu number.



The selected menu is indicated by a flashing symbol.

3. **OK**

Confirm and open the selected menu.



OFF flashes.

4. **^** / **v**

Select the desired setting (e.g. On).



5. **OK**

Each setting must be confirmed with the OK button.



Confirming the entry takes you to the next setting or back to the menu.

6. **M**

Back to the standard display.

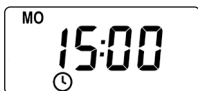

Example



Pressing the menu button briefly takes you back one menu step. Pressing and holding the button always take you to the standard display.

The installation wizard, which guides you through the first basic settings, is automatically started for the initial commissioning or after a software reset.

Exiting the installation wizard

Pressing the **M** button for one second causes the installation wizard to be cancelled prematurely.

Readiness for operation

The Troll Comfort or Troll Comfort 3D are ready for operation after completing the settings.

1. The installation wizard is shown after switching on the mains voltage. The digits start flashing.

2.  Set and confirm the current time.

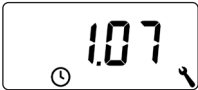
3.  Set the current date (day. month) and confirm each setting.

4.  Set and confirm the current year.

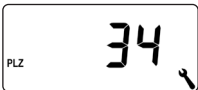
5.  Enter the first two digits of your German postcode [**PLZ**] or the desired international time zone.

Time zone table, see page 107.

6.

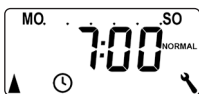

Set and confirm the opening time [▲].

Pre-setting: MO...SO (MON...SUN)

The opening time applies to the entire week. If necessary, you can subsequently select one of three switching time programmes in menu 9.5, see page 83.

6.1



Configure the switching time mode for the opening time [▲].

Switching time mode, see page 49

◆ **NORMAL**

The roller shutter opens at the configured opening time.

◆ **ASTRO**

The roller shutter opens at the daily recalculated dawn time. The previously configured opening time is interpreted as “**earliest at xx:xx hours**”.

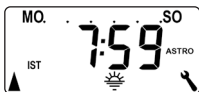

If **ASTRO** is selected, then the opening time calculated for the current day appears after pressing the OK button.

6.2



Continue to set the closing time.

7.

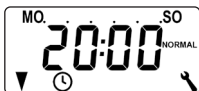

Set and confirm the closing time [▼].

Pre-setting: MO...SO (MON...SUN)

The closing time applies to the entire week. If necessary, you can subsequently select one of three switching time programmes in menu 9.5, see page 83.

7.1  /  > 

Configure the switching time mode for the closing time [▼].

Switching time mode, see page49

◆ **NORMAL**

The roller shutter closes at the configured closing time.

◆ **ASTRO***

The roller shutter closes at the daily recalculated dusk time.

◆ **SENSOR***

The roller shutter closes daily at dusk, as measured by the light sensor.

*The previously configured closing time is interpreted as "**latest at xx:xx hours**".

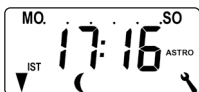

If **ASTRO** is selected, then the closing time calculated for the current day appears after pressing the OK button.

7.2 

Confirm the settings.

8.

The standard display is shown after the final setting, see example.

The Troll Comfort or Troll Comfort 3D is now ready for operation.







You have the option of deactivating individual switching times as required. In order to do so, the value [**OFF**] can be selected after the value [**23:59**].



13. Manual operation

Manual operation is possible from the standard display at any time and has priority over the programmed automatic functions.

Example for manual control of a roller shutter

1.  Open the roller shutter.
Pressing the button briefly causes the roller shutter to move to the upper end point.
2.  /  or  causes the roller shutter to stop intermittently.
3.  Close the roller shutter.
The roller shutter moves to the configured **ventilation position** or to the lower end point.

Ventilation position, see page 80

If the ventilation position is configured, the roller shutter will first roll down to this position. Pressing the [**Down**] button once more causes the roller shutter to continue downwards.



14. Moving to a target position

EN

If necessary, you can enter an arbitrary target position for your roller shutter which you can then move to directly. Moving to the target position and stopping the roller shutter is done automatically.

Automatic movement after approx. two seconds

The device will initiate movement to the configured target position automatically if no button is pressed for approx. two seconds.



In order to use this function, it is necessary to previously determine and configure the **run time** for the connected tubular motor, see page 78.

The ventilation position is ignored when moving to the target position.

1.  / 

Display the current position of the roller shutter by briefly pressing one of the buttons.

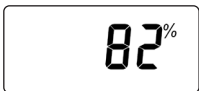



The current position is given as a percentage [%].

2.  / 

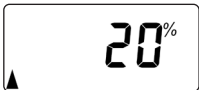
Enter the desired target position (e.g. 20 %) by repeatedly pressing the button.



The arrows [/] show the resulting direction of travel.













Value = roller shutter position

0 % = fully open



100 % = fully closed

3. The roller shutter will automatically move to the target position and stop after approx. two seconds.

Main menu

Symbol	Menu	Page
AUTO	1 Automatic mode	47
	2 Switching times	48
	3 Automatic dusk function	61
	4 Automatic sun function	65
	5 Automatic dawn function	69
	6 Random function	71
	7 Automatic wind function *	72
	8 Automatic rain function *	74
	9 System settings	76
SET	9.1 Time and date	77
	9.2 Motor run time	78
	9.3 Ventilation position	80
PLZ	9.4 Postcode	82
	9.5 Switching time programme	83
	9.6 Blockage detection *	85
 T	9.7 Venetian blind mode	88

* not available for the **Troll Comfort 3D**

i	9.8	Device settings	90
	9.8.1	Automatic summer / winter changeover	91
	9.8.2	Display contrast	92
	9.8.3	Display lighting	92
	9.8.4	Timer mode *	93
	9.8.5	Button lock	94
	9.8.6	Inputs E1/E2 *	95
	9.8.7	Reversal of rotation direction	97
L	9.8.8	Light function *	98
	9.8.9	End points *	101
i	9.8.0	Software version	103

** not available for the **Troll Comfort 3D***



Automatic mode on (symbol on the standard display)

- ◆ All set automatic functions are active
- ◆ Manual operation is also possible in automatic mode



Automatic mode off (symbol on the standard display)

- ◆ All automatic functions are deactivated
- ◆ All automatic symbols are deactivated on the standard display
- ◆ Inputs E1 and E2 will not be taken into consideration - unless the automatic wind function is activated.

Switching automatic mode on/off in menu 1

1.



Open menu 1.

2.



Set and confirm the desired setting.

OFF = automatic mode off

On = automatic mode on

Toggle directly on the standard display



1 sec.

Press the OK button for one second on the standard display.



17. Switching times (opening and closing times) [▲/▼], brief description

EN

You can configure various **opening [▲]** and **closing times [▼]** for the Troll Comfort or Troll Comfort 3D in order to open or close your roller shutter automatically at your preferred times.

For this purpose, there are three switching time programmes available in menu 9.5, see page 83:

[1] Weekly switching times (factory setting)

The switching times [▲/▼] apply from **(MO SO)** (MON...SUN).

[2] Working day and weekend switching times

Separate switching times [▲/▼] for **(MO FR)** (MON...FRI) and **(SA + SO)** (SAT + SUN).

[3] Individual day switching times

The switching times [▲/▼] can be set for every day of the week **(MO / DI / MI / DO / FR / SA / SO)** (MON / TUES / WED / THURS / FRI / SAT / SUN).

Doubling the switching times by activating a second switching time block

If necessary you can double the number of available opening and closing times. In order to do so, a second **switching time block (n = 2)** must be activated in menu **9.5**, see page 48 / 84.

If a second switching time block has been activated [**n2**], you can select the desired switching time block [**1 or 2**] prior to setting the opening and closing times.



The switching times in the second switching time block [**2**] **cannot** be linked to a switching time mode [**NORMAL / ASTRO / SENSOR**].



17. Switching times (opening and closing times) [▲/▼], brief description

EN

Application example for a second switching time

You can use a second switching time, for example, to darken a child's bedroom at midday:

- ◆ The **first opening time** has been set to 8:00 hours.
- ◆ The roller shutter will open at 08:00 hours
- ◆ The roller shutter should close again at 12:00 hours and open again at 14:30 hours.
- ◆ In order to do so, the **second switching time block** must be selected and the respective **second opening and closing time** must be set accordingly.
- ◆ The **first closing time** has been set to 20:00 hours.
- ◆ The roller shutter will close at 20:00 hours.

Selecting a switching time mode

Various **switching time modes** can be selected when configuring the opening and closing times.

The following switching time modes are possible:

- ◆ **NORMAL**
- ◆ **ASTRO**
- ◆ **SENSOR (only for closing times)**

Brief description of the switching time modes

- ◆ **NORMAL**
The roller shutter moves at the configured switching time.
For more, see next page.



17. Switching times (opening and closing times) [▲/▼], brief description

EN

◆ ASTRO

Calculation of the respective switching time by means of an astro programme

The opening and closing times are calculated in relation to the date and postcode. Subsequently, they are linked to the previously configured switching times.

● Link to the opening time [▲]

The roller shutter opens at the daily calculated dawn time. The configured **opening time** is interpreted as **“earliest at xx:xx hours”**.

● Example a:

- Dawn begins at 5:00 hours.
- The opening time has been set to 7:00 hours.
- The roller shutter will open at 07:00 hours.

● Example b:

- Dawn begins at 08:00 hours.
- The opening time has been set to 7:00 hours.
- The roller shutter will open at 08:00 hours.

● Link to the closing time [▼]

The roller shutter closes at the daily calculated dusk time. The previously configured **closing time** is interpreted as **“latest at xx:xx hours”**.

● Example a:

- Dusk begins at 17:00 hours.
- The closing time has been set to 20:00 hours.
- Your roller shutter will close at 17:00 hours

● Example b:

- Dusk begins at 22:00 hours.
- The closing time has been set to 20:00 hours.
- Your roller shutter will close at 20:00 hours



17. Switching times (opening and closing times) [▲/▼], brief description

EN

◆ SENSOR (only for closing times [▼])

The closing time is controlled by a light sensor in relation to the level of brightness.

In addition, the measured dusk value is linked to the previously configured closing time. The configured closing time is interpreted as **"latest at xx:xx hours"**.

● Example a:

- In winter dusk begins, for example, at approx. 17:00 hours.
- The closing time has been set to 20:00 hours.
- Your roller shutter will close at 17:00 hours

● Example b:

- In summer dusk begins, for example, at approx. 22:00 hours.
- The closing time has been set to 20:00 hours.
- Your roller shutter will close at 20:00 hours



You have the option of deactivating individual switching times as required. In order to do so, the value [**OFF**] can be selected after the value [**23:59**].

Subsequently, the switching time will not be executed (even in ASTRO or SENSOR modes).



17.1 Menu 2 - Configuring opening and closing times [▲/▼]

EN

If the type of switching time programme (weekly switching times, working day / weekend switching times or individual day switching times) is not to be changed, start directly with **point 2**.

1. If you want to change the type of switching time programme, first open menu **9.5**, see page 83 and configure the desired switching time programme.

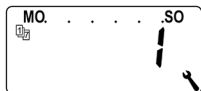
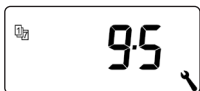

- 2.



Open menu **2** if the desired switching time programme is already active.

The active switching programme is shown at the top of the display while you set the opening and closing times.

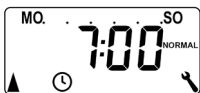

Weekly switching times



Weekday / weekend switching times



Individual day switching times



17.1 Menu 2 - Configuring opening and closing times [▲/▼]

EN

The following serves to describe the procedure for setting an **opening and closing time** [▲/▼] as **weekly switching times**.

3.

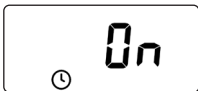

Activate and confirm the switching times.

On = switching times on
Off = switching times off

4.

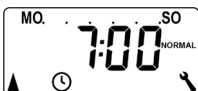

Set and confirm an **opening time** [▲].

4.1



Configure the **switching time mode for the opening time** [▲].

Switching time mode, see page 49

◆ **NORMAL**

The roller shutter opens at the configured opening time.

◆ **ASTRO**

The roller shutter opens at the daily recalculated dawn time. The previously configured opening time is interpreted as **"earliest at xx:xx hours"**.



If **ASTRO** is selected, then the opening time calculated for the current day appears after pressing the OK button.

4.2



Continue to set the closing time.



17.1 Menu 2 - Configuring opening and closing times [▲/▼]

EN

5.

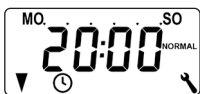

Set and confirm the closing time [▼].

5.1



Configure the switching time mode for the closing time [▼].

Switching time mode, see page 49

◆ **NORMAL**

The roller shutter closes at the configured closing time.

◆ **ASTRO***

The roller shutter closes at the daily recalculated dusk time.

◆ **SENSOR***

The roller shutter closes daily at dusk, as measured by the light sensor.

*The previously configured closing time is interpreted as "**latest at xx:xx hours**".

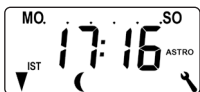

If **ASTRO** is selected, then the closing time calculated for the current day appears after pressing the OK button.

6.



Exit the settings and return to main menu.



17.1 Menu 2 - Configuring opening and closing times [▲/▼]

Information about the [ASTRO] switching time mode

If [ASTRO] is selected as the switching time mode, the calculated dusk time can be individually customised by means of an offset between **-60** and **+60 minutes**.

- ◆ Dusk can be configured in menu **3**, see page 61.
- ◆ Dawn can be configured in menu **5**, see page 69.

Information about the [SENSOR] switching time mode

If [SENSOR] is selected as the switching time mode, then the desired **dusk limit value** can be configured in menu **3**, see page 61.

If you intend to operate the Troll Comfort or Troll Comfort 3D and the connected tubular motor according to brightness levels, then you must connect the optionally available RADEMACHER light sensor to the Troll Comfort or Troll Comfort 3D.

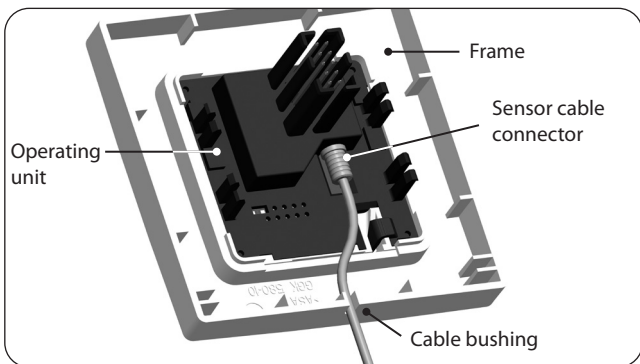

1. Carefully remove the operating unit from the installation housing.
2. Insert the light sensor cable connector * into the socket on the rear of the operating unit.
3. Feed the sensor cable into the cable bushing in the frame and guide it out.
4. Carefully place the operating unit with the frame back into the installation housing.

* Accessories, see page 109



ATTENTION!

Excessive bending can damage the sensor cable.

The sensor cable is a fibre optic cable. Avoid excessive bending or crushing of the sensor cable.

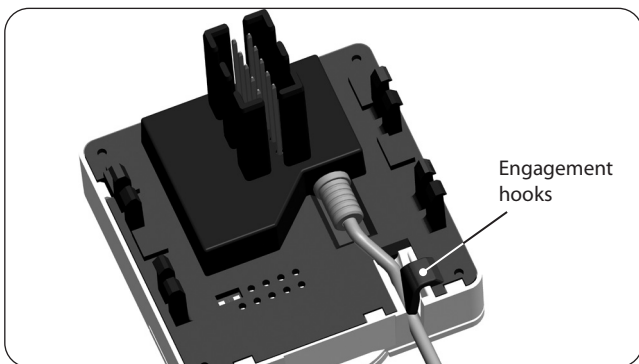

1. Carefully remove the operating unit from the installation housing.
2. Insert the light sensor connector into the socket on the rear of the operating unit.
3. Lay the sensor cable in the cable bushing of the operating unit.
The sensor cable can be pressed into the engagement hooks with the help of a rounded object (for example, a 50 cent coin).
4. Carefully place the operating unit together with the frame back into the installation housing, see next page.



18.2 Light sensor connection when using a frame supplied by other manufacturers

EN



If the cable bushing of the operating unit is covered by the frame, then it will be necessary to fit the additionally provided spacer frame onto the rear of the operating unit.

It may be necessary to use an intermediate frame 50 x 50 *, depending on the respective switch range used.

** Not included*

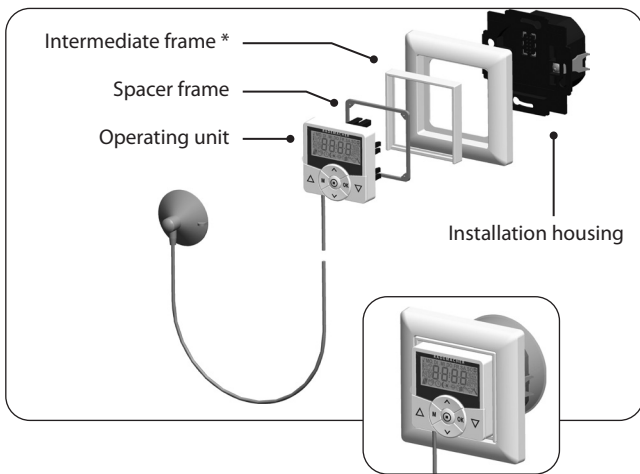

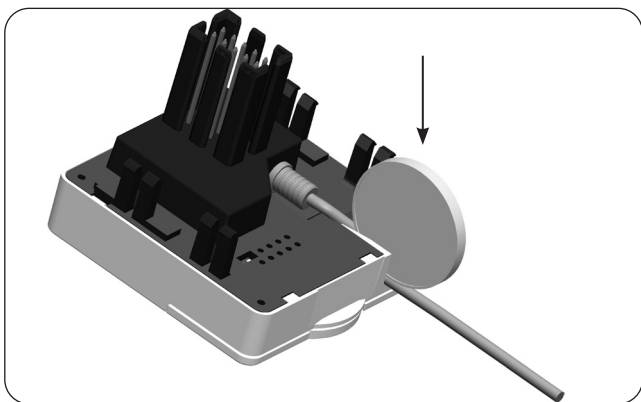

1. Carefully pull the operating unit out of the installation housing.
2. If the sensor cable has been fixed in place by means of the operating unit's engagement hooks, then it must first be released, for example, with the help of a 50 cent coin.
3. Pull the light sensor connector out of the socket.
4. Replace the operating unit back into the installation housing.



19. Automatic dusk function, brief description

The automatic dusk function causes the roller shutter to close automatically to the lower end point or configured ventilation position.

You can choose between two automatic dusk functions:

- ◆ **Automatic dusk function with astro programme**
= switching time mode [**ASTRO**]
- ◆ **Automatic dusk function with light sensor**
= switching time mode [**SENSOR**]

Automatic dusk function with astro programme

The dusk time is recalculated every day based on the geographical location and the current date (defined by the configured postcode). This means that it is not necessary to continuously readjust the closing time throughout the year.

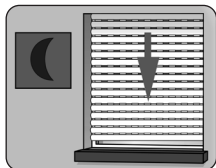

Configuring a custom offset period

An offset can be configured between **-60 and +60 minutes** in order to customise the calculated dusk time to your personal preferences.



A light sensor is not required for this function!



19. Automatic dusk function, brief description

EN

Automatic dusk function with connected light sensor

At dusk, the roller shutter will lower to the lower end limit or to the configured ventilation position after approx. 10 seconds. The roller shutter will open again once the configured opening time is reached or in the event of a manual command.

The required dusk limit value is configurable.

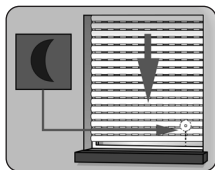

**Installation of the
light sensor, see
page 57.**



The automatic dusk function with a light sensor is only executed once per day.



19.1 Menu 3 - Customising the automatic dusk function

EN

1. Open menu 3.

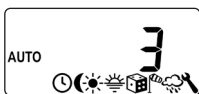

2. Customise the automatic dusk function in accordance with the selected switching time mode [**NORMAL / ASTRO or SENSOR**]:

NORMAL



No customisation is possible in this switching time mode.

OK Return to main menu.

ASTRO

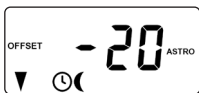

Set the offset.

The offset function can be used to modify the calculated astro time by **+/- 60 minutes**.

Example:

With a negative offset e.g. **- 10**, the calculated astro time is triggered 10 minutes earlier.

Subsequently, the resulting closing time is displayed.

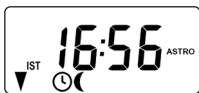

OK Return to main menu.



SENSOR



Customise the **dusk limit value** in switching time mode [**SENSOR**].

If the set limit is not met due to the onset of dusk, the roller shutter will close.



ACTUAL value

Currently measured brightness (e.g. 12).

- - = too bright



SET value

Configurable set limit

01 = very dark, approx. 2 lux

15 = less dark, approx. 50 lux



Return to main menu.



20. Automatic sun function, brief description

EN

The automatic sun function enables brightness-dependent control of your roller shutter. To do this, a local light sensor is secured to the window with a suction cup and then plugged into the Troll Comfort or Troll Comfort 3D.

Automatic sun function

Automatic movement of the roller shutter once a set limit is exceeded. The roller shutter end position can be freely selected by changing the **position of the local light sensor** on the window.

Please note the state of the sun symbol on the standard display



When the automatic sun function is active, the sun symbol flashes on the standard display as soon as the configured set limit is exceeded.

Automatic lowering

If uninterrupted sunlight is detected for 10 minutes, the roller shutter will descend until its shadow covers the light sensor.

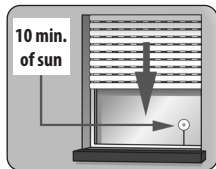

Automatic clearing

After approx. 20 minutes, the roller shutter is automatically raised a small amount to uncover the sensor. If the sun continues to shine, then the roller shutter remains in this position.

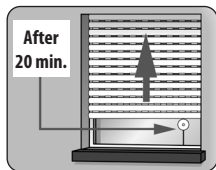



Automatic opening

If the brightness decreases below the configured set limit value, the roller shutter will return to the upper end point.



The above-mentioned delay times can be exceeded in the event of changing weather conditions.

The automatic sun function will be terminated and must be reactivated if required after the following events:

- ◆ After manual actuation.
- ◆ After execution of an automatic function.
- ◆ After the upper end point is reached.



20.1 Menu 4 - Configuring the automatic sun function

EN

1. Open menu 4.



2. Activate and confirm the automatic sun function.



On = automatic sun function on
Off = automatic sun function off

3. Adjust the **local sun limit value**.

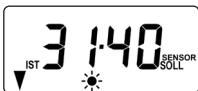

Configure the **local sun limit value**:

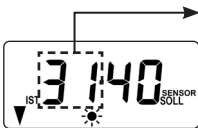

ACTUAL value

Currently measured brightness (e.g. 31).

-- = too dark

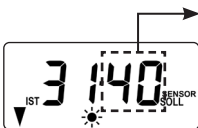

SET value

Configurable set limit:

31 = minimal sun, approx. 2000 lux

45 = bright sunlight, approx. 20000 lux



Return to main menu.



Sunshine position for activated automatic slat adjustment

If you have activated automatic slat adjustment in menu **9.7**, you must set an arbitrary sunshine position on your Troll Comfort or Troll Comfort 3D manually that your roller shutter should lower to when the automatic sun function is activated.



The **run time** must be configured prior to setting the sunshine position, see page 78.

Information about the sunshine position

- ◆ The locally mounted light sensor may not be covered by the roller shutter when it is moving downwards.
- ◆ Set the sunshine position in a way that the roller shutter remains above the light sensor. Otherwise the light sensor cannot correctly measure the brightness level.

4. Configure the **local sunshine position**.



Move the roller shutter to the desired position.

or



The arrow [▼] indicates the direction of travel.



Enter the desired sunshine position, e.g. 50 %.

Value = roller shutter position

0 % = fully open

100 % = fully closed



Confirm the sunshine position and return to main menu.



21. Automatic dawn function, brief description

The automatic dawn function causes the roller shutter to open automatically to the upper end point.

When configuring opening times [▲], it is possible to link them to a switching time mode, see page 49.

The calculated dawn time can be customised by linking the opening times with the [ASTRO] switching time mode. This means that it is not necessary to continuously readjust the opening time throughout the year.

Link to the opening time [▲]

The previously configured opening time is interpreted as **“earliest at xx:xx hours”**.

Configuring a custom offset period

The calculated dawn time can be customised to personal preferences by means of an offset between **-60 and +60 minutes**. An application example for the [ASTRO] switching time mode is included on page 50.



1. Open menu 5.



2. Customise the dawn time in accordance with the selected switching time mode:

NORMAL

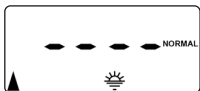

No customisation is possible in this switching time mode.



Return to main menu.

ASTRO



Set the offset.

The offset function can be used to modify the calculated astro time by +/- **60 minutes**.

Example:

With a negative offset e.g. - **10**, the calculated astro time is triggered 10 minutes earlier.

Subsequently, the resulting opening time is displayed.



Return to main menu.



22. Menu 6 - Configuring the random function

EN

The random function enables a random delay of the set timer periods ranging between 0 and 30 minutes.

The random function is executed for:

All automatic opening and closing times.

Please note the state of the cube symbol on the standard display



The cube symbol flashes on the standard display when the random function is activated during the period in which the movement command is being delayed.

1. Open menu **6**.



2. Select and confirm the desired setting.



On = random function on
Off = random function off

Subsequently, the main menu will be displayed again.



23. Automatic wind function, brief description (not available for the Troll Comfort 3D)

EN

This function enables you to use the Troll Comfort to operate, for example, a connected Venetian blind in relation to the weather conditions.

As soon as an external signal transducer detects "**wind**", the control signal is transferred to the Troll Comfort via one of the correspondingly configured inputs (**E1 or E2**).

Configuration of inputs E1 / E2

See page 95, menu **9.8.6**

The direction of rotation in the event of wind can be configured.

In the event of windy conditions, the Venetian blind can be retracted or a draught stop can be closed.

If the automatic wind function is active ...



- ◆ The wind symbol flashes.
- ◆ Manual operation is no longer possible.
- ◆ Automatic movement commands are no longer carried out but will be resumed as soon as the wind subsides. In each case, only the last automatic movement command is subsequently executed.



In manual mode, the automatic wind function remains active, for example, in order to keep an awning protected from wind at all times.



If the rotation direction for wind is set to **DOWN** and wind is detected when the drive is at the upper end position, then the drive moves back to the upper end position as soon as no more wind is detected.



In the main menu, the wind symbol is only displayed if an external input (**E1 or E2**) is configured for the automatic wind function.



23.1 Menu 7 - Configuring the automatic wind function (not available for the Troll Comfort 3D)

EN

ATTENTION!

The following settings may only be undertaken when the wind is still in order to prevent damage to the awnings / Venetian blinds.

1. Open menu 7.



2. Select and confirm the desired setting.

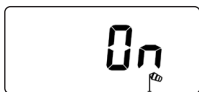

On = automatic wind function on
Off = automatic wind function off

3. Configure and confirm the **rotation direction in the event of wind.**

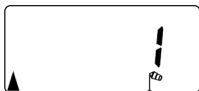

1 = up (factory setting)
2 = down

Subsequently, the main menu will be displayed again.



24. Automatic rain function, brief description (not available for the Troll Comfort 3D)

EN

This function enables you to use the Troll Comfort to operate, for example, a connected awning in relation to the weather conditions.

As soon as an external signal transducer detects "**rain**", the control signal is transferred to the Troll Comfort via one of the correspondingly configured inputs (**E1 or E2**).

Configuration of inputs E1 / E2

See page 95, menu **9.8.6**

The direction of rotation in the event of rain can be configured.

The awning can be retracted (**up**) or used as a rain cover (**down**) in the event of rain.

Once the automatic rain function is active ...



- ◆ The rain symbol flashes.
- ◆ Manual operation is still possible.
- ◆ Automatic movement commands are no longer carried out but will be resumed as soon as the rain subsides. In each case, only the last automatic movement command is subsequently executed.



The automatic rain function is also switched off in manual mode.



If the rotation direction for rain is set to **down** and rain is detected when the drive is at the upper end position, then the drive moves back to the upper end position as soon as no more rain is detected.



In the main menu, the rain symbol is only displayed if an external input (**E1 or E2**) is configured for the automatic rain function.



24.1 Menu 8 - Configuring the automatic rain function (not available for the Troll Comfort 3D)

EN

ATTENTION!

The following settings may only be undertaken in dry weather in order to prevent damage to the awnings / Venetian blinds.

1. Open menu **8**.

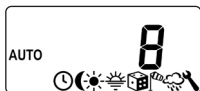

2. Select and confirm the desired setting.

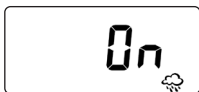

On = automatic rain function on
Off = automatic rain function off

3. Configure and confirm the **direction of rotation in the event of rain**.

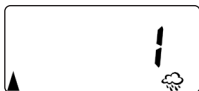





1 = up (factory setting)
2 = down

Subsequently, the main menu will be displayed again.



This menu enables you to configure additional devices and system settings to customise your Troll Comfort or Troll Comfort 3D to your individual preferences.



Menu 9 - System settings

Symbol	Menu	Page
SET	9.1 Time and date	77
	9.2 Motor run time	78
▼	9.3 Ventilation position	80
PLZ	9.4 Postcode	82
	9.5 Switching time programme	83
	9.6 Blockage detection *	85
 T	9.7 Venetian blind mode.....	85
 i	9.8 Device settings	90

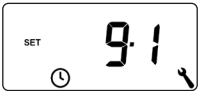
** not available for the **Troll Comfort 3D***

-  Open menu **9.1**.
Configure and confirm the desired settings.

Setting order:

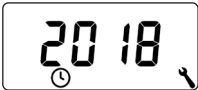
-  Time
-  Date
Day.Month
-  Year
2000 to 2099



Configuring the run time allows specific targeted positions to be assumed based on the run time and roller shutter position.

The run time setting must be configured if:

- ◆ You intend to use the ventilation position function, see page 80.
- ◆ You intend to use the sunshine position function (only if automatic slat function is activated, see page 88).
- ◆ You intend to configure and move to any target position , see page 44.

The run time can be detected directly by the Troll Comfort or Troll Comfort 3D or you may, for example, measure and configure it with the help of a timer.

Measurement information and run time setting:



- ◆ Tubular motor run times can vary depending on temperature. For this reason, targeted movement to a specific position is subject to certain tolerances.
- ◆ The run time must be configured as precisely as possible in order for the desired positions to be reliably assumed.
- ◆ The run time must be reconfigured if the end points are changed.
- ◆ If the run time is configured, for example, with the help of a timer, then the speed should be measured in the up direction and approx. 10 % should be added.



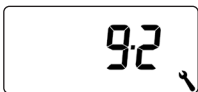



1. Open menu **9.2**.



Measuring the run time directly with the Troll Comfort:

2.  Press the button until the roller shutter stops at the lower end point.
3.  Press the button until the roller shutter stops at the upper end point and then release it again.
The run time will be timed and stored during the up cycle.
4.  Back to system menu.

Measuring and entering the run time manually:

1.  Fully close the roller shutter.
2.  >>  Subsequently move the roller shutter to the upper end point and measure the time required.
3.  Enter and confirm the measured run time (e.g. 15 sec.) in menu **9.2**.



25.3 Menu 9.3 - Configuring the ventilation position

EN

If you do not want the roller shutter to close fully to the lower end point, you can use this function to configure an arbitrary position (**e.g. as the ventilation position**).

When closing automatically, the roller shutter stops at the ventilation position, but it can subsequently be fully closed manually.



The run time must be configured prior to setting the ventilation position, see page 78.

1.

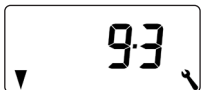

Open menu **9.3**.

2.

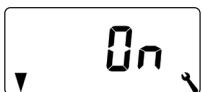

Activate / deactivate the ventilation position and confirm.

On = ventilation position on *

Off = ventilation position off **

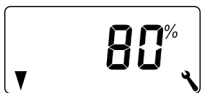

* After activation, the current ventilation position appears.

** After deactivation, the display jumps back to the menu.

3.



First fully open the roller shutter.



4.  / 

or

 / 



Then move the roller shutter to the desired position.

Enter the desired ventilation position manually.

Value = roller shutter position

0 % = fully open

100 % = fully closed



If the position is set to **0 % or 100 %**, then the ventilation position will be deactivated.

5. 

Finally, confirm the ventilation position.

1. Open menu **9.4**.

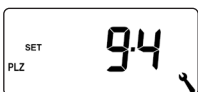

2. Enter the first two digits of your German postcode or the desired international time zone.

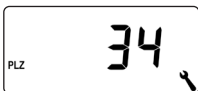

Time zone table, see page 107.

34 = factory setting



If the Troll Comfort or Troll Comfort 3D are not being used in Germany, it may be necessary to switch off the automatic summer/winter changeover function. In order to do so, please refer to page 91 "**Activating/deactivating the automatic summer/winter changeover**".

The number of opening and closing times that can be configured depends on the desired switching time programme selected in this menu.

There are three switching time programmes available:

[1] Weekly switching times (factory setting)

The switching times [▲/▼] apply from **(MO SO)** (MON...SUN).

[2] Working day and weekend switching times

Separate switching times [▲/▼] for **(MO FR)** (MON...FRI) and **(SA + SO)** (SAT + SUN).

[3] Individual day switching times

The switching times [▲/▼] can be set for every day of the week **(MO / DI / MI / DO / FR / SA / SO)** (MON / TUES / WED / THURS / FRI / SAT / SUN).

Doubling the switching times [▲/▼] by activating a second switching time block:

If you want to double the number of opening and closing times, then you must activate a second **switching time block (n = 2)** here.

After this has been activated, you can subsequently configure opening and closing times for both switching time blocks, see page 48.

1.

Open menu **9.5**.

2.

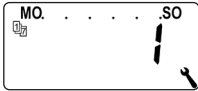

Select and confirm the desired switching time programme.

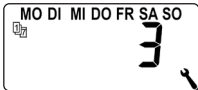

3.

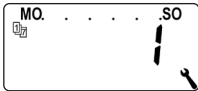
Configure and confirm the number of **switching time blocks**.

n1 = one switching time block is active *
n2 = two switching time blocks are active

* Recommended setting



The switching times [▲/▼] are configured in menu **2**, see page 52.



25.6 Menu 9.6 - Configuring the blockage detection (not available for the Troll Comfort 3D)

EN

The Troll Comfort is able to monitor the torque of motors equipped with a mechanical end point setting. This enables the controller to switch off the motor in the event of overloading or blockage. As a result, the roller shutter is protected from damage.



Blockage detection can only be used in combination with a tubular motor **with mechanical end point setting**.

1.  Open menu **9.6**.

2.  Activate/deactivate the blockage detection and confirm.

On = blockage detection on *
Off = blockage detection off **

* Continue with point 3.

** After deactivation and confirmation, the display jumps back to the menu.

3.  Select and confirm the suitable motor type.

A list of the motor types is provided on the following page.



Please also read the instruction manual for the tubular motor being used.



25.6 Menu 9.6 - Configuring the blockage detection (not available for the Troll Comfort 3D)

EN

Motor types	Ø	Power
1:06	35 mm	6 Nm
1:10	35 mm	up to 10 Nm
2:10	45 mm	up to 10 Nm
2:20	45 mm	up to 20 Nm
2:30	45 mm	up to 30 Nm
2:40	45 mm	up to 40 Nm
2:50	45 mm	up to 50 Nm

If the installed motor type is unknown, please select:

1:06 for roller shutters with an area of up to 1.5 m²

2:30 for larger roller shutters

4.

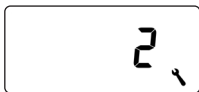

Set and confirm the sensitivity.

Sensitivity:

1 = low

6 = high



Test runs should be made to ascertain the highest possible sensitivity in order to protect the roller shutter in the event of blockage.



It may be necessary to customise the **cut-off sensitivity** depending on the properties of the roller shutter (weight, running characteristics etc.).

5.

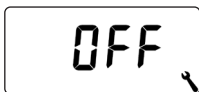

Activate/ deactivate the **reversing function** after a blockage is detected.

On = reversing function on

Off = reversing function off



25.6 Menu 9.6 - Configuring the blockage detection (not available for the Troll Comfort 3D)

Automatic reversing function in the event of a blockage

In the event of a blockage, the motor immediately runs in the opposite direction for approx. 2 seconds to release the roller shutter.

More information about the blockage detection:

- ◆ If longer connecting leads are used (>5 m), it is possible that the blockage detection system will fail to work correctly due to external interference.
- ◆ It is possible that the motor will be switched off by the blockage detection system when moving out of the end points when using mechanical motors with high switching hysteresis. Blockage detection must be deactivated for this type of motor.



Some motors can trigger undesired reversing when reaching the end positions (e.g. atypical internal motor wiring, long leads etc.). In such cases, it is recommended to deactivate the reversing function.



If the motor type cannot be precisely determined, then a suitable setting for motor type and sensitivity must be determined by trial and error.

This function enables you to use the Troll Comfort or Troll Comfort 3D to control a Venetian blind.

The following configurations are possible:

- ◆ Jog mode
- ◆ Automatic slat adjustment
- ◆ Tilting time

Brief description of jog mode

Tapping the operating buttons briefly enables Venetian blind slats to be conveniently configured.



In order to conveniently move the Venetian blind to the end points, actuate the control button for 1 second longer than the configured tilting time. Once the button is released, the Venetian blind will move to the end point without stopping.



Brief description of the automatic slat adjustment function

If the Troll Comfort or Troll Comfort 3D controls the Venetian blind motor in the **down-direction** until the total run time has elapsed or the Venetian blind motor is stopped manually, then the motor reverses automatically for a brief period (automatic slat adjustment). This serves to position the slats to the desired angle in order to provide sun shading to the room.

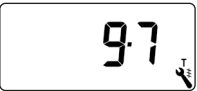

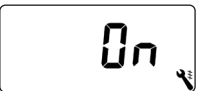

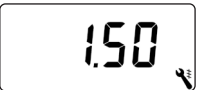

If the motor is actuated by the automatic sun function to the sunshine position, then automatic slat adjustment is not executed. The light sensor must be mounted as low as possible under the configured sunshine position.

1.  Open menu **9.7**.
2.  Activate or deactivate the jog mode and confirm.
On = jog mode on
Off = jog mode off
3.  Activate or deactivate the automatic slat adjustment function and confirm.
On = automatic slat adjustment function on *
Off = automatic slat adjustment function off **

* Continue with point 4.
** After deactivation and confirmation, the display jumps back to the menu.
4.  Configure and deactivate the tilting time.
Setting range:
Off or 0.1 to 5.00 seconds
5.  Confirm the last setting and return to the menu.

**Menu 9.8 - Device settings**

Symbol	Menu	Page
	9.8.1 Automatic summer / winter changeover	91
	9.8.2 Display contrast	92
	9.8.3 Display lighting	92
	9.8.4 Timer mode *	93
	9.8.5 Button lock	94
	9.8.6 Inputs E1/E2 *	95
	9.8.7 Reversal of rotation direction	97
	9.8.8 Light function *	98
	9.8.9 End points *	101
	9.8.0 Software version	103

** not available for the **Troll Comfort 3D***



26.1 Menu 9.8.1 - Switching the automatic summer/winter time on/off

EN

The Troll Comfort and Troll Comfort 3D feature an automatic summer/winter changeover function.

Summer time

The timer is changed to summer time on the last Sunday in March. The timer is set back one hour at 02:00 hours.

Winter time

The timer is changed to winter time (standard time) on the last Sunday in October. The timer is set back one hour at 03:00 hours.

Recommendation for operating the device outside Germany

If the Troll Comfort or Troll Comfort 3D are not being used in Germany, it may be necessary to switch off the automatic summer/winter changeover function.

1.  Open menu **9.8.1**.

2.  Activate or deactivate the summer/winter changeover function and confirm.

On = function on
Off = function off



26.2 Menu 9.8.2 - Setting the display contrast

EN

1. Open menu **9.8.2**.

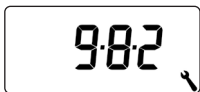

2. Set and confirm the desired contrast.



1 = low contrast
10 = high contrast



26.3 Menu 9.8.3 - Setting the permanent display lighting

Pressing one of the operating buttons switches the background lighting on the display on and off after a predetermined time.

- ◆ After 10 seconds on the standard display
- ◆ After approx. 1 minute in the menus

You can set the desired brightness level if the background lighting should remain permanently lit up in an idle state (without pressing a button):

1. Open menu **9.8.3**.

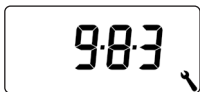

2. Set and confirm the desired brightness levels.

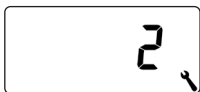

0 = deactivate the permanent display lighting
1 = low brightness
2 = average brightness
3 = maximum brightness



26.4 Menu 9.8.3 - Setting the timer mode (not available for the Troll Comfort 3D)

This menu enables you to configure the time base for the internal timer (depending on the local power supply).

1.

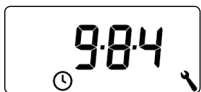

Open menu **9.8.3**.

2.

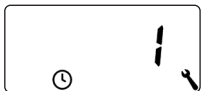

Set and confirm the desired timer mode.

1 = 50 Hz operation (factory setting)

e.g. in Europe

2 = 60 Hz operation

e.g. in the USA

3 = Quartz timer

for other mains frequencies



You can activate the automatic button lock to protect against any unintentional input.

1. Open menu **9.8.5**.

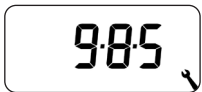

2. Activate/deactivate the button lock and confirm.

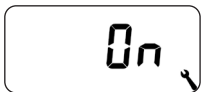

On = button lock on
Off = button lock off

Automatic activation after approx. two minutes

If the button lock is activated and no buttons are pressed within a period of two minutes, the button lock is switched on automatically.

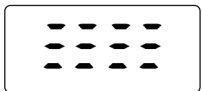

If an attempt is made to call up the menu when the button lock is active, the display flashes.

The button lock is deactivated manually on the standard display

-  4 sec. Press and hold for 4 seconds.

The button lock is activated manually on the standard display before the time limit expires

-  4 sec. Press and hold for 4 seconds if you want to activate the automatic button lock before the two minutes expire.



Manual operation of the Troll Comfort or Troll Comfort 3D is also possible when the button lock is active.



26.6 Menu 9.8.6 - Configuring the inputs E1/E2 (not available for the Troll Comfort 3D)

External control via two inputs E1 and E2

The Troll Comfort features two configurable inputs E1 and E2 (230 V / 50 Hz) for connecting external signal transducers (e.g. Venetian blind switches / environmental sensors etc.).

The following configurations are possible:

- [0] Off
- [1] UP (roller shutter mode)
- [2] DOWN (roller shutter mode)
- [3] UP (Venetian blind mode)
- [4] DOWN (Venetian blind mode)
- [5] UP / Stop / Down
- [6] Automatic mode on/off (closer, NO)
- [7] Automatic mode on/off (opener, NC)
- [8] External wind signal, NO
- [9] External rain signal, NO



If manual mode is active, the inputs are not taken into consideration by the controller (except in the case of the wind function).



Both inputs can be configured independently of each other.



26.6 Menu 9.8.6 - Configuring the inputs E1/E2 (not available for the Troll Comfort 3D)

EN

1.

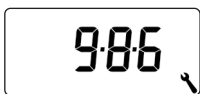

Open menu **9.8.6**.

2.

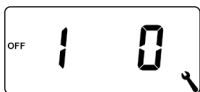

Set and confirm the function for input 1 (**E1**).

3.

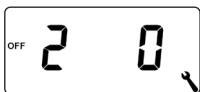

Set and confirm the function for input 2 (**E2**).



You can obtain application examples for inputs E1 / E2 from our website at www.rademacher.de



26.7 Menu 9.8.7- Switching the reversal of rotation direction on/off

EN

It is not necessary to re-wire the motor if the direction of rotation of the connected motor is wrong ([Up] button moves the roller shutter downwards and [Down] button moves the roller shutter upwards). The direction of the motor can be easily changed using the **reversal of rotation direction** function.

1. Open menu **9.8.7**.

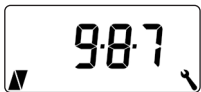

2. Activate or deactivate the reversal of rotation direction function and confirm.
On = reversal of rotation direction on
Off = reversal of rotation direction off

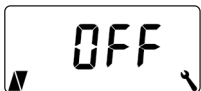

The following also applies for the Troll Comfort

The following settings apply when the light function is activated:

On = device mode

Off = light mode

Light function,
see page 98.

Comparison of functions,
see table on page 99



26.8 Menu 9.8.8 - Configuring the light function (not available for the Troll Comfort 3D)

EN

The light function makes it possible to control a connected light (or another electrical appliance) instead of a roller shutter motor with the help of the automated functions.

In addition, it is also possible to manually control the light with the buttons [**Up / Down and SET/Stop**].

The underlying functions of the Troll Comfort change when the light mode is activated.

When a lamp (or another electrical appliance) is controlled instead of a motor, the following motor-related functions on the Troll Comfort are meaningless and no longer function:



- ◆ Run time
- ◆ End point setting
- ◆ Jog mode
- ◆ All Venetian blind functions
- ◆ Automatic wind and rain functions
- ◆ Sunshine and ventilation position



26.8 Menu 9.8.8 - Configuring the light function (not available for the Troll Comfort 3D)

EN

Comparison of functions in light and device mode

Command / signal	Light function off	Light function on	
	Tubular motor mode	Light mode Reversal of rotation direction = off	Device mode Reversal of rotation direction = on
	Up	Off	On
	Stop	Off	Off
	Down	On	Off
Dusk	Down	On	Off
Dawn	Up	Off	Off
Sun	Down	Off	No function



26.8 Menu 9.8.8 - Configuring the light function (not available for the Troll Comfort 3D)

EN

1.

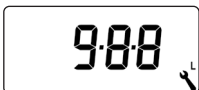

Open menu **9.8.8**.

2.

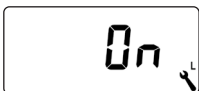

Activate/deactivate the light function and confirm.

On = light function on

Off = light function off

Choosing between the light and device function

When the light function is activated, a choice can be made between the [**light mode**] and [**device mode**] in menu **9.8.7 Reversal of rotation direction**, see page 97.



26.9 Menu 9.8.9 - Configuring the end points of the tubular motor



EN

(not available for the Troll Comfort 3D)

You can use the Troll Comfort to configure the end points of a connected RADEMACHER electronic tubular motor.

- ◆ [SET] is additionally displayed during the active end point setting process.
- ◆ The end point function is only available for RADEMACHER electronic tubular motors from 2000 onwards.
- ◆ The end point setting cannot be adjusted for tubular motors connected in parallel.
- ◆ The end point function is not available when the light function is activated, see page 98.

The end points will only be stored if:

- ◆ The tubular motor is allowed to run for at least four seconds before an end point is reached.
- ◆ The configuration process is undertaken starting from the end point that is to be changed.
- ◆  /  Check the correct setting of the end points directly after completing the configuration process with the help of the operating buttons.







26.9 Menu 9.8.9 - Configuring the end points of the tubular motor

EN

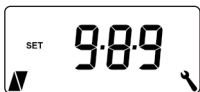
(not available for the Troll Comfort 3D)

1. Open menu **9.8.9**.



2.  /  /  Allow the tubular motor to run for approx. 2 seconds to enable the connected motor type to be detected:

Possible displays:



The tubular motor type has not been detected.
No end point setting is possible.

 Return to menu.

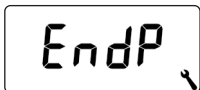

The motor type has been detected, continue with the end point settings.

3. Setting the upper end point.



Press and hold the button. The roller shutter travels upwards.

- 3.1 Release the button as soon as the desired end point is reached.
The upper end point is stored in the tubular motor.

4. Setting the lower end point.



Press and hold the button. The roller shutter travels downwards.

- 4.1 Release the button as soon as the desired end point is reached.
The lower end point is stored in the tubular motor.

5.  Return to menu.



26.10 Menu 9.8.0 - Displaying the software version

EN

This menu enables the current software version of the Troll Comfort or Troll Comfort 3D to be displayed.

1. Open menu **9.8.0**.

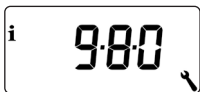

2. The current software version is subsequently displayed.

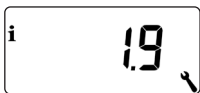

3.  /  Display the device version.



C = "Troll" Comfort
3d = "Troll" Comfort 3D

4.  /  Perform a display test.



5.  Return to menu **9.8** - Device settings.

A software reset can be performed to reset the Troll Comfort or Troll Comfort 3D to the original default condition as when supplied.

1.  +  +  + 

Press and hold the four buttons simultaneously for five seconds until ...

all the symbols are shown on the display.



Then the device type (C = Comfort) and software version are displayed for five seconds.

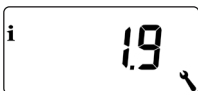

All settings are deleted and reset to the factory settings.

3. Start with the settings as specified from page 40 onwards (installation wizard).

A hardware reset can be performed in the event that the Troll Comfort or Troll Comfort 3D no longer react to commands.

1. To do so, pull the operating unit out of the installation housing.

2. The centre section on the rear of the operating unit contains an opening with two contacts that must be carefully bridged for a few seconds, for example, with the help of a flat-head screwdriver.

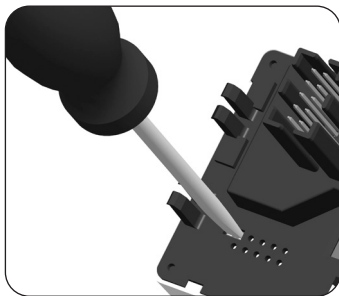

3. The operating unit can be returned to the installation housing as soon as the screwdriver has been removed from the contacts.

The time and date will be lost during a hardware reset. All other settings are retained.

Error 2 (display “E2”)

Internal device error highlighting that the Troll Comfort or Troll Comfort 3D may be defective.

- ◆ Please then contact RADEMACHER Service, see page 112.

30. Dismantling

There is a risk of fatal electric shock when touching electrical components.

- ◆ Disconnect all phases of the mains power lead and secure it to prevent any reconnection. Check that the system is de-energised.
1. Switch off the mains power, secure it against restarting and check that the system is de-energised.
 2. Carefully pull the operating unit out of the installation housing.
 3. Remove the frame.
 4. Release the claw fasteners of the installation housing and pull it out of the flush-mounted box.
 5. Disconnect the connecting cable from the installation housing.
 6. Secure the connection point against restarting and the connecting cable from unintentional contact.

Belgium

- 101 Antwerp
- 102 Bruges
- 103 Brussels
- 104 Liège
- 105 Mechelen
- 106 Mons
- 107 Ostend

Denmark

- 108 Aalborg
- 109 Ringsted
- 110 Esbjerg
- 111 Horsens
- 112 Kolding
- 113 Copenhagen
- 114 Svendborg
- 115 Randers

Great Britain

- 116 Aberdeen
- 117 Birmingham
- 118 Bristol
- 119 Glasgow
- 120 London
- 121 Manchester
- 122 Newcastle

Estonia

- 123 Tallinn

Finland

- 124 Helsinki
- 125 Jyväskylä
- 126 Oulu
- 127 Tampere
- 128 Turku
- 129 Vasa

France

- 130 Bordeaux
- 131 Brest
- 132 Dijon
- 133 Le Havre
- 134 Lyon
- 135 Montpellier
- 136 Nantes
- 137 Nice
- 138 Paris
- 139 Reims
- 140 Strasbourg
- 141 Toulon

Italy

- 142 Bologna
- 143 Bolzano
- 144 Florence
- 145 Genoa
- 146 Milan
- 147 Naples
- 148 Palermo
- 149 Rome
- 150 Turin
- 151 Venice

Ireland

- 152 Cork
- 153 Dublin
- 154 Belfast

Latvia

- 155 Riga

Liechtenstein

- 156 Vaduz

Lithuania

- 157 Vilnius

Luxembourg

- 158 Luxembourg

The Netherlands

- 159 Amsterdam
- 160 Eindhoven
- 161 Enschede
- 162 Groningen
- 163 Maastricht
- 164 Rotterdam
- 165 Utrecht

Norway

- 166 Oslo
- 167 Stavanger
- 168 Bergen
- 169 Trondheim

Austria

- 170 Amstetten
- 171 Baden
- 172 Braunau
- 173 Brixen
- 174 Bruck/Mur
- 175 Eisenstadt
- 176 Graz
- 177 Innsbruck
- 178 Klagenfurt
- 179 Landeck
- 180 Linz
- 181 Nenzing
- 182 Salzburg
- 183 Vienna

Poland

- 184 Breslau
- 185 Bromberg
- 186 Gdańsk

187	Kattowitz	218	Badajoz	252	Sofia
188	Kraków	219	Burgos	253	Skopje
189	Lodz	220	Cáceres	254	Thessaloniki
190	Lublin	221	Castellón	255	Zagreb
191	Posen	222	Granada		
192	Szczecin	223	Guadalajara		
193	Warsaw	224	La Coruña		
	Portugal	225	Lérida		
194	Faro	226	León		
195	Lisbon	227	Madrid		
196	Porto	228	Murcia		
	Switzerland	229	Oviedo		
197	Basel	230	Palma		
198	Bern	231	Pamplona		
199	Andermatt	232	San Sebastián		
200	Chur	233	Seville		
201	Lausanne	234	Santander		
202	Lucerne	235	Valencia		
203	Zurich	236	Valladolid		
	Sweden	237	Vitoria		
204	Boras	238	Zaragoza		
205	Gävle	239	La Palma		
206	Göteborg	240	Tenerife		
207	Helsingborg	241	Gran Canaria		
208	Jönköping	242	Fuerteventura		
209	Östersund		South-east Europe		
210	Malmö	243	Athens		
211	Stockholm	244	Belgrade		
212	Sundsvall	245	Bratislava		
213	Umeå	246	Bucharest		
	Spain	247	Budapest		
214	Almería	248	Istanbul		
215	Alicante	249	Maribor		
216	Barcelona	250	Prague		
217	Bilbao	251	Sarajevo		



32. Simplified EU declaration of conformity

EN



RADEMACHER Geräte-Elektronik GmbH hereby declares that the Troll Comfort and Troll Comfort 3D comply with the Directives **2014/35/EU (Low Voltage Directive)** and **2014/30/EU (EMC Directive)**.

The full text of the declaration of conformity is available at the following website:

www.rademacher.de/ce



33. Accessories

Light sensor

Item no.	Cable length
7000 00 88	0.75 m
7000 00 89	1.5 m
7000 00 90	3 m
7000 00 91	5 m
7000 00 92	10 m



RADEMACHER Geräte-Elektronik GmbH provides a 24-month warranty for new systems that have been installed in compliance with the installation manual. All construction faults, material defects and manufacturing defects shall be covered by the warranty.

Your statutory warranty claims remain unaffected by this warranty.

The following are not covered by the warranty:

- ◆ Incorrect fitting or installation
- ◆ Non-observance of the installation and operating manual
- ◆ Improper operation or wear and tear
- ◆ External influences, such as impacts, knocks or weathering
- ◆ Repairs and modifications by third parties, unauthorised persons
- ◆ Use of unsuitable accessories
- ◆ Damage caused by unacceptable excess voltages (e.g. lightning)
- ◆ Operational malfunctions caused by radio frequency overlapping and other such radio interference

A prerequisite for the warranty is that the new device must have been purchased from one of our approved specialist retailers. Proof of this must be provided by presenting a copy of the invoice.

RADEMACHER will remedy any defects that occur within the warranty period free of charge either by repair or by replacement of the affected parts or by supplying a new replacement unit or one to the same value. There is no general extension of the original warranty period by delivery of a replacement or by repair as per the terms of the warranty.

RADEMACHER

Geräte-Elektronik GmbH
Buschkamp 7
46414 Rhede (Germany)
info@rademacher.de
www.rademacher.de

Service:

Hotline 01807 933-171*
Telefax +49 2872 933-253
service@rademacher.de

* 30 seconds free of charge, subsequently
14 cents / minute from German fixed line
networks and max. 42 cents / minute from
German mobile networks.