

DuoFern HomeTimer 9498-UW / 9498-AL















Instruction manual for the electrical connection and for commissioning

Item no.:

3250 13 71 (ultra-white)

3250 13 81 (aluminium)



i	These instructions.....	4	17.5	Switch the automatic timer on/off for individual DuoFern actuators	43
1.	Key to symbols	4	17.6	Automatic dusk function	44
2.	Safety information.....	5	17.7	Menu 3 - Customising the automatic dusk function []	44
3.	Proper use	5	17.8	Automated solar function.....	46
4.	Improper use	6	17.9	Menu 4 - Switching the automated solar function on/off []	46
5.	Included in delivery	7	17.9.1	Setting the local sunshine position.....	47
6.	General view - operating unit	8	17.10	Automatic dawn function []	48
6.1	Brief description of the keys	9	17.11	Menu 5 - Customising the automatic dawn time []	48
7.	Display symbol legend.....	10	17.12	Menu 6 - Configuring the random function []	50
8.	General view - back / exchanging the battery	11	18.	Menu 9 - System settings []	51
9.	Menu overview - main menu and system settings.....	12	18.1	Menu 9.1 - Set time and date []	52
9.1	Menu overview - menu 9.8 / menu 9.9.....	13	18.2	Menu 9.2 - Configure motor running time	52
10.	Brief description	14	18.3	Menu 9.3 - Configure ventilation position []	54
10.1	Compatible switch ranges	15	18.4	Menu 9.4 - Set postcode [PLZ]	55
10.2	Overview of features	16	18.5	Select Menu 9.5 - Switching time programme []	56
11.	Assembly	18	18.6	Menu 9.7 - Set jog mode [T]	57
12.	Important information prior to initial commissioning.....	19	18.7	Menu 9.8 - Device settings []; menu overview	58
13.	Brief description of the standard display and main menu	19	18.7.1	Menu 9.8.1 - Automatic summer/winter change-over on/off.....	59
13.1	Opening and closing the menus (example).....	21	18.7.2	Menu 9.8.3 - Set display backlighting.....	59
13.2	Group and single control	22	18.7.3	Menu 9.8.5 - Switch key lock on/off	60
14.	Initial commissioning with the help of the installation wizard	22	18.7.4	Menu 9.8.7 - Switch reversal of rotation direction on/off	61
15.	Manual operation	27	18.7.5	Menu 9.8.9 - Configuration of end points for the tubular motor.....	62
15.1	Manual operation - jog mode.....	28	18.7.6	Menu 9.8.0 - Display software version	63
16.	DuoFern settings.....	29			
16.1	Menu 9.9.1 - Logging DuoFern actuators on/off.....	30			
16.2	DuoFern radio code	33			
16.3	Remote log on / off.....	35			
17.	Menu overview / main menu.....	36			
17.1	[AUTO] Automatic mode	36			
17.2	Menu 1- Automatic mode on / off	37			
17.3	Switching times [ / ]	38			
17.4	Menu 2 - Configuration of opening and closing times [ / ]	40			

19. Software reset (restore factory settings).....	64	23. Factory settings	66
20. Dismantling	65	24. Time zone table	67
21. Simplified EU Declaration of Conformity	65	25. Warranty conditions	69
22. Technical Specifications	66		

...describe how to install and operate your **DuoFern HomeTimer**.



Before you begin, please read these instructions through completely and follow all the safety instructions.

This manual is a component of the product. Please store it in an easily accessible place. When passing the DuoFern HomeTimer on to a third party, this manual must be passed on as well.

Damage resulting from non-compliance with these instructions and safety instructions will void the guarantee. We assume no liability for any consequential damage.

1. Key to symbols



Risk of fatal electric shock.

This sign warns of danger when working on electrical connections, components, etc. It requires that safety precautions be taken to protect the life and health of the person concerned.



This concerns your safety.

Please pay particular attention and carefully follow all instructions marked with this symbol.



This is to draw your attention to information that is important for trouble-free operation.



Please read the operating instructions for external actuators described at this point, (e.g. a tubular motor).



The use of defective equipment can lead to personal injury and damage to property (malfunction).

- ◆ Never use defective or damaged equipment. Please contact our Customer Service department in the event of faults, see page 72.



Incorrect use leads to an increased risk of injury.

- ◆ Children may not be permitted to play with the DuoFern HomeTimer.
- ◆ Train all personnel to use the DuoFern HomeTimer safely.
- ◆ Avoid allowing persons with limited abilities to operate the equipment and prevent children from playing with fixed controllers.

3. Proper use

Only use the **DuoFern HomeTimer** for controlling DuoFern actuators (e.g. DuoFern tubular motor actuators / universal actuators, etc.) for:

- ◆ Roller shutters
- ◆ Venetian blinds and slats
- ◆ Awnings
or
- ◆ lamps and other electrical appliances

Operating conditions:

- ◆ The associated tubular motor must be fitted with a mechanical or electronic end position switch.
- ◆ Only use the DuoFern HomeTimer in dry rooms.
- ◆ The DuoFern HomeTimer is battery-operated. It is not possible to connect it to the mains.
- ◆ The installation and operation of the DuoFern HomeTimer is only permitted for those systems and devices where a malfunction in the transmitter or receiver would not cause a danger to personnel or property or where this risk is already covered by other safety equipment.

Radio systems which transmit on the same frequency can cause interference.

Using the DuoFern HomeTimer for purposes other than previously mentioned is impermissible and is regarded as improper use.

- ◆ Never use the DuoFern radio system and its components (e.g. DuoFern HomeTimer) for remote control of devices and systems with heightened safety-relevant requirements or where there is a heightened risk of accidents. This shall require additional safety equipment. Observe the respective statutory regulations for the installation of such systems.
- ◆ Do not install the DuoFern HomeTimer outside.

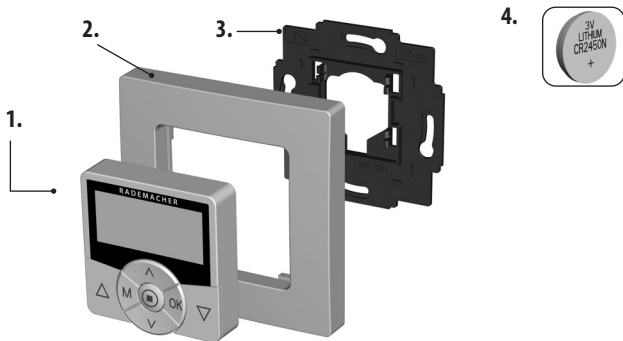

Legend

1. Control unit (50 x 50 mm)
 2. Frame
 3. Wall bracket
 4. 1 x battery (type CR2450)
- 1 x double-sided adhesive strip (not illustrated)
Operating instructions (not illustrated)

Installation, see page 18

[1] Operating unit

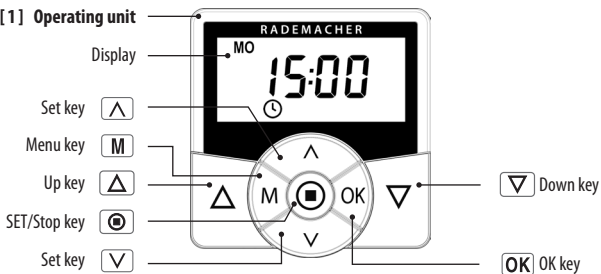

△ **Operating keys [Up / Down]**

- ◆ Manual operation [Up △/ Down ▽] or [On / Off].

⊙ **SET/Stop key, [⊙]**

- ◆ Manual roller shutter stop or manual [Off].
- ◆ Key lock on/off (press for 4 seconds, only if key lock is active).

M **Menu key, [M]**

- ◆ Open / close the main menu.
- ◆ Go back one step (e.g. to close a menu)
- ◆ Back to standard display (press for 1 second).

∧ **The set keys, [∧/∨]**

- ◆ Select actuators (devices) (individually or group control).
- ◆ Select the desired menu item.
- ◆ Setting the parameters (increase / decrease) / pressing and holding a key for an extended period causes the digits to change more quickly.

OK **[OK] key**

- ◆ Toggle auto/manual mode (press for 1 second).
- ◆ Confirms and opens the selected menu.
- ◆ Confirm entry.
- ◆ Continue to next entry.



Setting display illumination,
see page 59.

[MO ... SO] Week days (MON...SUN)

88:88 Time / setting parameters

 DuoFern icon

 Information

 Switching time programme

[OFFSET] OFFSET (for Astro time)

[SET] Setting

[AUTO] Automatic operation

[PLZ] Postcode

[IST] ACTUAL value

 Direction of travel - up / down

 Automatic mode off

 Timer periods

 Automatic dusk function

 Automated solar function

 Automatic dawn function

 Random function

 System settings

[T] Jog mode

[NORMAL] Switching modes

[ASTRO]



Danger to life from acid burns

- ◆ Keep children away from new and used batteries. If a battery has been swallowed, medical assistance must be requested immediately.
- ◆ In case of contact with the skin, eyes or mucous membranes, there is a risk of burns from the battery acid.
- ◆ Take leaking batteries out of the device immediately.

Initial commissioning

The battery is factory-fitted in the battery compartment together with a separating film. Carefully pull out the separating film. Subsequently the operational demonstrator starts up automatically, see page 22.

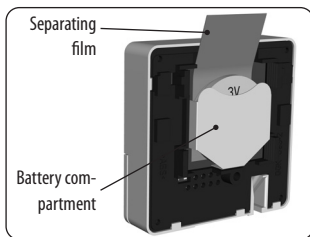

Battery replacement

Carefully slide the battery out of the battery compartment using a flat, non-conductive object (e.g. a plastic rod).

Pay attention to the correct polarity when inserting a new battery.

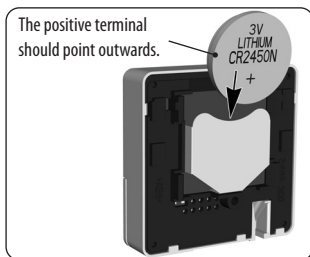

M

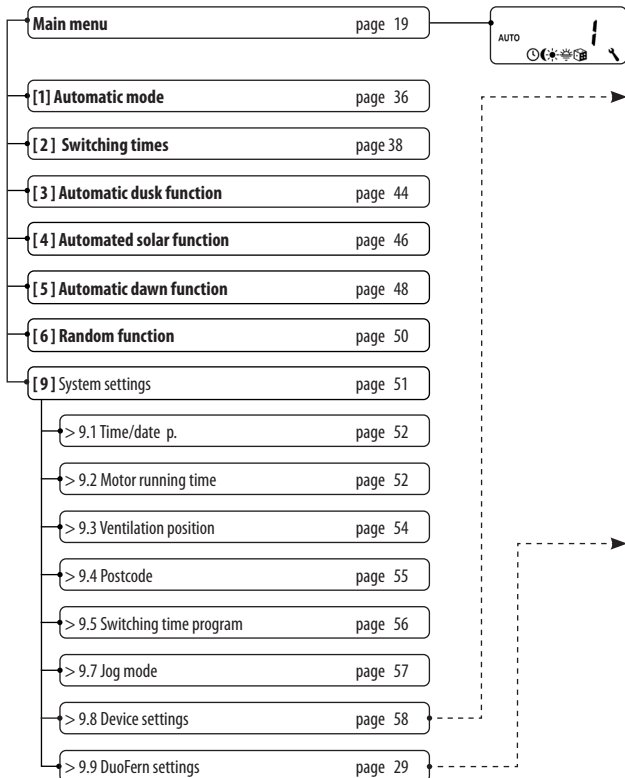

----->	> 9.8 Device settings	page 58
	> 9.8.1 Summer / Winter changeover	page 59
	> 9.8.3 Display backlighting	page 59
	> 9.8.5 Key lock	page 60
	> 9.8.7 Reversal of rotation direction	page 61
	> 9.8.9 End points	page 62
	> 9.8.0 Software version	page 63

----->	> 9.9 DuoFern settings	page 29
	> 9.9.1 Logging on/off	page 30
	> 9.9.7 DuoFern radio code	page 33
	> 9.9.8 Remote login/off	page 35

The battery-operated **DuoFern HomeTimer** serves for controlling and configuring up to 20 DuoFern actuators. The **DuoFern HomeTimer** offers the option of manually controlling and setting a **pair of switching times** for all registered DuoFern actuators.

The DuoFern receivers (actuators) and transmitters must be connected to the DuoFern network.

You can find a detailed description of the various functions, configuration options and possible combinations for the DuoFern system at:

<http://www.rademacher.de/duofern>.

The following DuoFern devices cannot be registered, configured or controlled with the DuoFern HomeTimer:

- ◆ DuoFern sensors
- ◆ DuoFern transmitters

Mounting with existing switches

The DuoFern HomeTimer can be integrated into many commercially available switch ranges. Suitable switch ranges are detailed in the following section.

Manufacturer	Switch range
BERKER	Arsys / K1 / S1
BUSCH-JAEGER	Busch-Duro 2000 Si / Reflex Si / alpha exclusive / alpha nea / solo / impuls
GIRA	Standard-System / S-Color-System / stainless steel range / Standard 55
JUNG	CD 500 / ST 550 / LS 990 / CDplus as per CD but with coloured rings
MERTEN	M1 / Atelier / Artec / Tracent / Antik Neu
PEHA	Standard / Dialog / Aura
LEGRAND	Creo / Tenara
VEDDER	Alessa (plus)

It may be necessary to use an adapter frame 50 x 50 * (DIN 49075), depending on the respective switch range used.

* not included

- ◆ Display background illumination
- ◆ Installation wizard for easy commissioning.
- ◆ Manual operation on site
- ◆ Group or single control possible
- ◆ Switching automatic mode on/off
- ◆ Easy configuration with menu-driven operation
- ◆ Timer periods
 - Configurable opening [▲] and closing times [▼]
- ◆ Switching time programme:
 - [1] Weekly switching times
 - One switching time pair [▲/▼] for [MO...SO] (MON...SUN)
 - [2] Weekday and weekend switching times
 - One switching time pair [▲/▼] for [MO...FR] (MON...FRI)
 - One switching time pair [▲/▼] for [SA + SO] (SAT...SUN)
 - [3] Individual day switching times
 - One switching time pair [▲/▼] for every day of the week
[MO / DI / MI / DO / FR / SA / SO] (MON / TUE / WED / THU / FRI / SAT / SUN)
- ◆ Automatic dusk function with "Astro" programme
- ◆ Switch the automated solar function on/off
 - Setting the sunshine position for the selected actuator
- ◆ Automatic dawn function with the "Astro" programme
- ◆ Random function (random delay of 0 to 30 minutes)
- ◆ Setting the motor running time
- ◆ Ventilation position
- ◆ End point setting
- ◆ Key lock
- ◆ Jog mode for Venetian blinds
- ◆ Switching reversal of rotation direction on/off
- ◆ Automatic summer / winter changeover
- ◆ Permanent storage of the settings

Description and configuration of the individual functions.

A precise description of the individual functions and settings is included starting on page 19.

DuoFern settings

The settings required for operating the equipment in a DuoFern network are specified starting on page 29.

The DuoFern HomeTimer is intended for surface-mounting. The supplied wall bracket [3] can be screwed in place or bonded to the wall.



Do not install the device above a height of 2 m.

Installation procedure:

1. Mount the wall bracket in the desired mounting position.

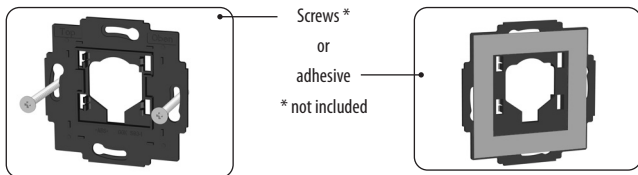

2. Carefully remove the separating film from the battery compartment, see page 11. Please ensure that none of the buttons are pressed during the mounting process.
3. Finally, apply slight pressure to insert the operating unit [1] and covering frame [2] into the wall bracket [3].

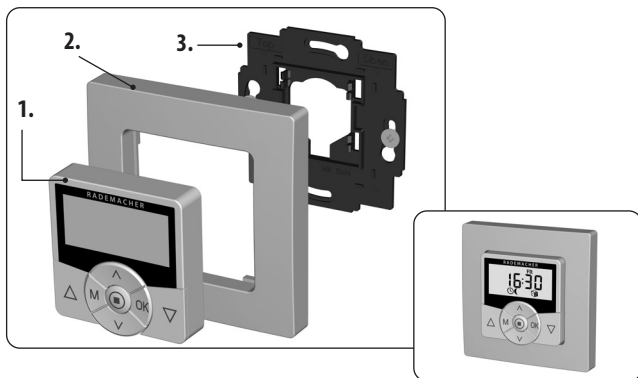

- ◆ Prior to initial commissioning of the DuoFern HomeTimer, it must be ensured that the end points are configured for all connected tubular motors and belt winders if they are being used for controlling roller shutters / Venetian blinds.
- ◆ If the end points have not yet been configured, it is vital that both end points are configured for all tubular motors and belt winders, as failure to do so can lead to malfunctions.
- ◆ In order to do so, follow the information provided in the operating manual for the respective tubular motor or belt winder.
- ◆ For electronic RADEMACHER tubular motors from year of manufacture 2000 onwards, the end points can be configured with the help of the DuoFern HomeTimer, see page 62.

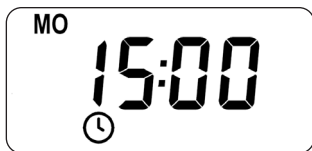

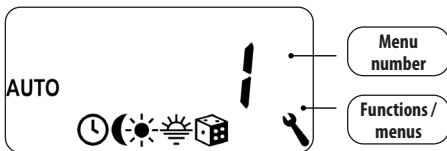

**The standard display (example)**

- ◆ Displays the current day of the week and time.
- ◆ Displays the activated functions.
- ◆ Manual operation of the DuoFern HomeTimer is only possible from the standard display.

The main menu

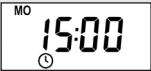

- ◆ Enables display and selection of the individual functions and menus.
- ◆ Manual operation is **not** possible from the main menu.
- ◆ No automatic control commands will be executed during the configuration process.
- ◆ If no key is pressed within 120 seconds, the display automatically changes from the active menu back to the standard display. Changes to settings are nevertheless saved.

<p>1. Calling up the main menu. By pressing the [M] key in the standard display.</p>	<p>[M]</p>	
<p>2. Select the desired menu or menu number. The selected menu is indicated by a flashing icon.</p>	<p>[^] [v]</p>	
<p>3. Open the menu by pressing the [OK] button.</p>	<p>[OK]</p>	
<p>4. Select the desired setting and confirm with [OK].</p>	<p>[^] [v] [OK]</p>	
<p>5. Subsequently the main menu will be displayed again.</p>		
<p>Pressing the [M] key from any of the menus will return you to the standard display.</p>	<p>[M] approx. 1 sec.</p>	

The DuoFern HomeTimer offers the option of simultaneously controlling [ALLE] (ALL) registered DuoFern actuators.

Alternatively, it is also possible to select individual actuators to be controlled.

Adjustment and control of multi-channel DuoFern actuators.

Multi-channel actuators enable you to select and control each channel independently from the others.



Please read the respective operating manual for the registered DuoFern actuator to find out which control signals and functions are supported.

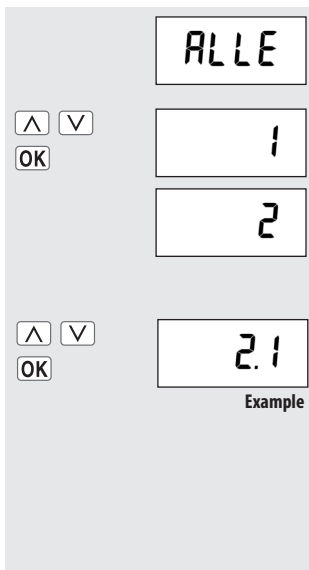

14. Initial commissioning with the help of the installation wizard

An installation wizard is available in order to help you configure the DuoFern HomeTimer quickly and easily. The wizard automatically guides you through the configuration process for **initial commissioning** or after a **software reset** (see page 64).

Quitting the installation wizard

Pressing the [M] key for one second causes the installation wizard to be cancelled prematurely.

Readiness for operation

The DuoFern HomeTimer is ready for use as soon as the installation wizard has finished. In addition, you can individually customise your settings and make changes at any time from the main menu and the system settings menu.

Configuration sequence for the installation wizard:

- > Time [12:00]
- > Date [Day.Month]
- > Year [2013]
- > Postcode [46]
- > Assign actuator [01 - nn]
- > Select switching time mode for opening time / [NORMAL / ASTRO / OFF]
- > Opening time [▲]
- > Select switching time mode for closing time / [NORMAL / ASTRO / OFF]
- > Closing time [▼]
- > DONE

1. Set and confirm the **time**.

Pressing a setting key for an extended period causes the numbers to progress more quickly.



2. Set and confirm the **date**.



3. Set and confirm the **year**.



4. Set and confirm the first two digits of your **German postcode [PLZ]** or the desired **international time zone**.



i 14. Initial commissioning with the help of the installation wizard EN

5. Registering mode starts automatically.
- ◆ The number of assigned DuoFern actuators is displayed.
 - ◆ Registering mode remains active for maximum 120 seconds.
 - ◆ It can be activated again by pressing the set key [▲].



The rotating bar indicates that registering mode is still active.

6. Switch all DuoFern actuators that you wish to control with the DuoFern HomeTimer one after the other to registering mode.



To do this read the operating instructions for the actuator in question.

7. Confirm the registering process as soon as all desired DuoFern actuators are successfully assigned.

OK

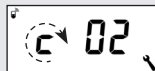

8. Configure the **switching time mode for the opening time** [▲]:

- ◆ **NORMAL**
- ◆ **ASTRO**
- ◆ **OFF**



OK

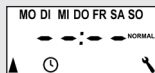

NORMAL

At the configured time, an [Up]-signal will be sent to the assigned DuoFern actuators.

Example:

The roller shutters open at the configured opening time.

ASTRO

The control command is sent at the daily re-calculated dawn time.

Example:

The roller shutters open at the daily re-calculated dawn time.

The previously configured opening time is interpreted as **earliest at xx:xx hours**.

OFF

No automatic control function is executed for [Up].

Switch time mode, see page 38.

i 14. Initial commissioning with the help of the installation wizard EN

8.1. The configured switching time mode will be sent to all registered DuoFern actuators.

- ◆ By way of confirmation, for example, the motors briefly start up and the display counts all registered actuators.
- ◆ In the event of a fault (for example, if an actuator cannot be reached), then the following message is shown:

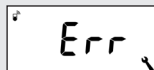
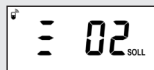

9. Set and confirm the **opening time** [▲].

Pre-setting:

This closing time mode applies to the entire week (MON...SUN) [MO...SO].

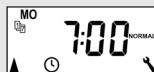

a) If [ASTRO] is selected, then the calculated opening time for the current day is displayed.

b) Configure the switching time mode for the closing time [▼].



Example:



10. Configure the **switching time mode for the closing time** [▼].

- ◆ NORMAL
- ◆ ASTRO
- ◆ OFF

NORMAL

At the configured time, an [Down]-signal will be sent to the assigned DuoFern actuators.

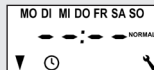

Example:

The roller shutters close at the configured closing time.

i 14. Initial commissioning with the help of the installation wizard EN

ASTRO

The control command is sent at the daily re-calculated dusk time.

The previously configured closing time is interpreted as **latest at xx:xx hours**.

OFF

No automatic control function is executed for [**Down**].

Example:

The roller shutters close at the daily calculated dusk time.

Switch time mode, see page 38.

- 10.1. The configured switching time mode will be sent to all registered DuoFern actuators.
Confirmation, see point 8.1

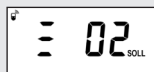

11. Set and confirm the **closing time [▼]**.

Pre-setting:

This closing time mode applies to the entire week (MON...SUN) [**MO...SO**].



- a) If [**ASTRO**] is selected, then the calculated closing time for the current day is displayed.
- b) Confirm the setting.

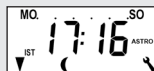

Example



12. The **standard display** is shown as soon as the final setting is confirmed. The DuoFern HomeTimer is now ready for operation.

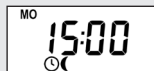

Example



You have the option of deactivating individual switching times as required. In order to do so, the value [**OFF**] can be selected after the value [**23:59**].

Manual operation is possible from the standard display at any time and has priority over the programmed automatic functions.

Group or single control

You can control [**ALLE**] (ALL) registered DuoFern actuators simultaneously or select individual actuators to be controlled, see page 22.



If nothing is selected, then the previously selected actuator will always be controlled.

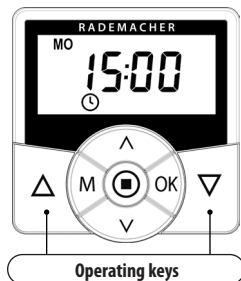

Example for manual control of a roller shutter

1. \triangleup / \triangledown > **OK**

Select and confirm the desired DuoFern actuator or [**ALLE**] (ALL).

ALLE

2

2. \triangleup

Open the roller shutters.

Briefly pressing the button causes the roller shutters to move to the upper end point.

3. \square

Causes the roller shutters to stop in the interim.

4. \triangledown

Close the roller shutters.

The roller shutters move to the configured **ventilation position** or to the lower end point.









Ventilation position, see page 54

If the ventilation position is configured, the roller shutters will first roll down to this position. Pressing the [**Down**] key once more causes the roller shutters to continue downwards.

As soon as jog mode is activated, it is possible to manually operate the DuoFern HomeTimer in jog mode. Jog mode provides a convenient way to configure Venetian blinds.

Pressing the respective operating key [**up / down**] for an extended period causes the DuoFern HomeTimer to automatically move the Venetian blinds to the corresponding end position.

Example for manual control of Venetian blinds in jog mode.

-
- | | | |
|----|---|--|
| 1. |  /  >  | Select and confirm the desired DuoFern actuator or [ALLE] (ALL). |
|----|---|--|
-
- | | | |
|----|---|--|
| 2. |  Press briefly | The Venetian blinds move upwards briefly. |
|----|---|--|
- or**
-
- | | | |
|------|---|---|
| 2.1. |  Press | The Venetian blinds open.
The Venetian blinds move up to the upper end point. |
|------|---|---|
-
- | | | |
|----|---|--|
| 3. |  | The Venetian blinds to stop in the interim. |
|----|---|--|
-
- | | | |
|----|---|--|
| 4. |  Press briefly | The Venetian blinds move downwards briefly. |
|----|---|--|
- or**
-
- | | | |
|------|---|--|
| 4.1. |  Press | The Venetian blinds close.
The Venetian blinds move to the configured ventilation position or to the lower end point. |
|------|---|--|

Ventilation position, see page 54

If the ventilation position is configured, the roller shutters will first roll down to this position. Pressing the [**Down**] key once more causes the roller shutters to continue downwards.



In order for your DuoFern HomeTimer to send and receive control signals to/from the DuoFern network, it is necessary to assign **each DuoFern actuator** (e.g. DuoFern tubular motor, etc.) onto the DuoFern HomeTimer



To do so, please read the operating instructions for the respective DuoFern actuator.

Maximum number of connected devices

You can assign a maximum of **20 DuoFern actuators** to a single DuoFern HomeTimer.

- ◆ The DuoFern HomeTimer cannot be connected to another DuoFern HomeTimer.
- ◆ The DuoFern HomeTimer is identified within the DuoFern network as a battery-operated sensor. For this reason, no other DuoFern sensors can be assigned to the DuoFern HomeTimer.
- ◆ Additional information about logging on can be obtained from the **login matrix** on our website under: **www.rademacher.de**

The following section serves to describe all required **DuoFern settings** for the DuoFern HomeTimer.

Menu 9.9 - DuoFern Settings

The DuoFern settings are undertaken in **Menu 9.9**. You can find an overview of all menus and sub-menus for the DuoFern HomeTimer on pages 12 and 13.



Menu 9 - System settings

Icon	Menu	Page
	9.9 DuoFern settings.....	29
	9.9.1 Logging on and off	30
	9.9.7 DuoFern radio code.....	33
	9.9.8 Remote log-on/off	35



1. Select and open menu **9.9.1 Log-on/off**.

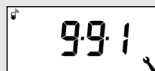

2. The number of assigned DuoFern actuators is displayed.



e.g. one actuator.

3. **Assign a DuoFern actuator.**

- a) Switch the desired DuoFern actuator to **registering mode**.
- b) Start the login procedure on the DuoFern HomeTimer.
- c) The display flashes [**On**].
- d) The **new number** of registered devices is displayed after successful login.
- e) Subsequently registering mode is automatically re-activated.
- f) Login the next DuoFern actuator.
or
- g) Back to menu selection.



e.g. two actuators



Repeat 3. a)

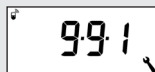



4. Log-off a registered DuoFern actuator.

- Switch the respective DuoFern actuator to **log-off mode**.
 - Start the log-off procedure on the DuoFern HomeTimer.
 - The display flashes [**OFF**].
 - The **new number** of registered devices is displayed after successful logout.
- Subsequently **registering mode** is automatically re-activated.
- Log-out the next DuoFern actuator.
- or
- Back to menu selection.



e.g. one actuator.



Repeat 3. a)

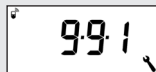

5. Delete all of the registered DuoFern actuators.

- If you want to delete all connections to all assigned DuoFern actuators, press and hold the set key [**V**] in **menu 9.9.1** for four seconds.
- Subsequently all of the connections will be deleted.



4 sec.

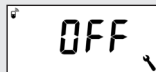



Clearing the DuoFern network.

This function enables you to log off all DuoFern actuators from the DuoFern HomeTimer that are no longer accessible via radio.



In order to prevent unintentional log-out, ensure that all DuoFern actuators are in range and operational before executing the clearing function.

1. Select and open menu **9.9.1 Log-on/off**.

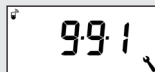

- a) The number of assigned DuoFern actuators is displayed.



2. Activate the **clear** function.

In order to do so, press and hold the key for approx. four seconds.



4 sec.

- a) The current number of registered DuoFern actuators flashes in the display.



- b) All currently registered DuoFern actuators will be displayed after successful clearance.



Example

3. Back to menu selection.





16.2 DuoFern radio code

EN

The radio code enables DuoFern actuators to be set to registering mode. This is especially useful for commissioning flush-mounted devices, as it is not necessary to dismantle them.

- ◆ The DuoFern actuator radio code is only active for a maximum period of 2 hours after connecting to the power for security reasons.
- ◆ The radio code is located on the bottom of the respective DuoFern actuator and on a label attached to the packaging.
- ◆ For DuoFern radio tubular motors you will find the radio code on the motor and on a label fitted to the connecting cable.



Please read the operating instructions for the relevant DuoFern actuator in order to activate the registering procedure.

Registering a DuoFern actuator per radio code to the DuoFern HomeTimer

1. Select and open menu **9.9.7 - Radio code.**



2. Successively enter the ten digit* radio code and confirm.

Only the flashing digit can be entered in each case.

* If you have a 6-digit radio code, enter a zero (0) for each of the 7th to 10th digits.

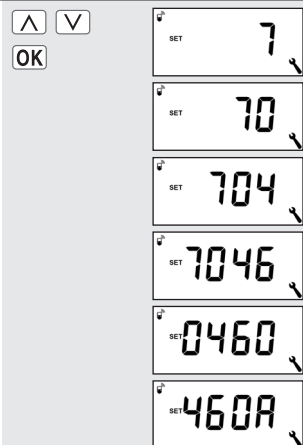



- a) After the final digit, the following displays are shown successively.



3. Activate **registering mode on the DuoFern actuator.**

or

Quit log-in/out mode in each case on the DuoFern actuator.



Registering mode remains active for maximum 120 seconds.

4. Back to menu selection.

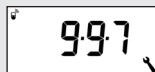

5. Select and open menu **9.9.1 Log-on/off.**

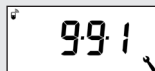

- a) The number of assigned DuoFern devices is displayed, see page 30.



- b) Start the **login procedure** on the **DuoFern HomeTimer.**



- c) The display flashes [**On**].

- d) The **new number** of registered devices is briefly displayed after successful login.

6. Back to menu selection.





16.3 Remote log on / off

EN

This function also enables DuoFern devices to be set to log-in/off mode, e.g. in order to register a DuoFern actuator to additional DuoFern transmitters.

- ◆ This function can only be used if the desired DuoFern actuator has previously been registered to the DuoFern HomeTimer.

Activate remote log on / off

1. Select and open menu **9.9.8 Remote log-on/off**.

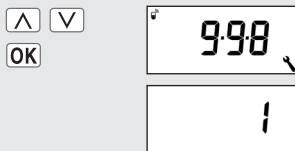

- a) The number of the first actuator is indicated on the display.

2. Select and confirm the desired DuoFern actuator.



3. If necessary, a brief test signal can be sent to the selected actuator in order for it to be uniquely identified.



4. Subsequently, the following display appears.



5. Continue with:
Activate registering mode on the DuoFern actuator.



or

Activate logout mode on the DuoFern actuator.







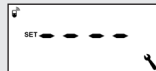

or

Quit log-in/out mode in each case on the DuoFern actuator.



Main menu

Icon	Menu	Page
AUTO	1 Automatic mode	36
	2 Switching times	38
	3 Automatic dusk control	44
	4 Automated solar function	46
	5 Automatic dawn control	48
	6 Random function	50
	9 System settings	51

i 17.1 [AUTO] Automatic mode

Automatic mode on

All of the activated automatic functions will be executed if the automatic mode is switched on. The corresponding icon is then shown in the standard display.

Manual operation is also possible in automatic mode.

Automatic mode off



Icon in standard display

- ◆ All automatic functions are deactivated; only manual operation is possible.
- ◆ All automatic icons are switched off in the standard display.

OK **Toggle directly to the standard display**

1. To do so, press and hold [OK] for approx. one second.
Toggling is carried out for all registered actuators.

[OK]
approx.
2 sec.



Switch on/off in menu 1

1. Call up the main menu.
2. Select and open menu 1 [AUTO]
3. Select and confirm the desired actuator or [ALLE] (ALL).
4. Select and confirm the desired setting.

[M]

[^] [v]
[OK]



[^] [v]
[OK]



[^] [v]
[OK]



On = Automatic mode on
Off = Automatic mode off

The respective icon flashes if configuration is successful.

5. Subsequently the main menu will be displayed again.





17.3 Switching times [▲/▼]

EN

You can configure various **opening [▲] and closing times [▼]** for the DuoFern HomeTimer in order to open or close your roller shutters at your preferred times.

For this purpose, there are three switching time programmes available in menu 9.5 [🔑] see page 56:

[1] Weekly switching times (factory setting)

- ◆ One switching time pair [▲/▼] for [MO...SO] (MON...SUN)

[2] Working day and weekend switching times

- ◆ One switching time pair [▲/▼] for [MO...FR] (MON...FRI)
- ◆ One switching time pair [▲/▼] for [SA + SO] (SAT...SUN)

[3] Individual day switching times

- ◆ One switching time pair [▲/▼] for every day of the week
[MO / DI / MI / DO / FR / SA / SO] (MON / TUE / WED / THU / FRI / SAT / SUN)

Selecting a switching time mode.

Various **switching time modes** can be selected when configuring the opening and closing times.

The following switching time modes are possible:

- ◆ NORMAL
- ◆ ASTRO
- ◆ OFF



◆ ASTRO

Calculation of the respective switching time by means of an "Astro" programme.

The opening and closing times are calculated in relation to the date and postcode. Subsequently they are linked to the previously configured switching times.

■ Link to the opening time [▲]

The roller shutters open at the daily calculated dawn time. The configured **opening time** is interpreted as "**earliest at xx:xx hours**".

Example a:

- Dawn begins at 5:00 a.m.
- The opening time has been set to 7:00 a.m.
- Your roller shutters will open at 7:00 a.m.

Example b:

- Dawn begins at 08:00 a.m.
- The opening time has been set to 7:00 a.m.
- Your roller shutters will open at 08:00 a.m.

■ Link to the closing time [▼]

The roller shutters close at the daily calculated dusk time. The configured **closing time** is interpreted as "**latest at xx:xx hours**".

Example a:

- Dusk begins at 17:00 hours.
- The closing time has been set to 20:00 hours.
- Your roller shutters will close at 17:00 hours.

Example b:

- Dusk begins at 22:00 hours.
- The closing time has been set to 20:00 hours.
- Your roller shutters will close at 20:00 hours.



You have the option of deactivating individual switching times as required. In order to do so, the value [OFF] can be selected after the value [23:59].

Subsequently the switching time will not be executed (even in ASTRO mode).



17.4 Menu 2 - Configuration of opening and closing times [▲/▼] EN

The following example shows how to configure an opening and closing time for Monday to Sunday.

If you want to configure the opening and closing times for another **switching time programme**, first open **menu 9.5** and select the desired **switching time programme**, see page 56.

1. Call up the main menu.

M

2. Select and open menu 2 [🕒] **switching times**.

▲ ▼

OK



3. Select [Alle] (All) DuoFern actuators.

▲ ▼

OK



4. Configure the **switching time mode for the opening time [▲]**:

- ◆ NORMAL
- ◆ ASTRO
- ◆ OFF

▲ ▼

OK

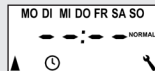

NORMAL

At the configured time, an [Up]-signal will be sent to the assigned DuoFern actuators.

ASTRO

The control command is sent at the daily re-calculated dawn time. The previously configured opening time is interpreted as “earliest at xx:xx hours”.

Example:

The roller shutters open at the configured opening time.

Example:

The roller shutters open at the daily re-calculated dawn time.



17.4 Menu 2 - Configuration of opening and closing times [▲/▼] EN

OFF

No automatic control function is executed for [Up].

- 4.1. If the switching time mode was changed, a control signal will be sent automatically to all DuoFern actuators logged in.

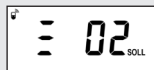

5. Set and confirm the **opening time** [▲].

The header of the display indicates which switching time programme is currently active (see example to the right).

Factory setting = weekly switching time [MO - SO] (MON - SUN)



Weekly switching times

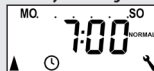

Weekday / weekend switching times



Individual day switching times

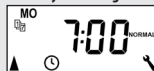

- a) If [ASTRO] is selected, then the calculated opening time for the current day is displayed.



- b) Continue at point 6.



6. Configure the **switching time mode** for the closing time [▼]:

- ◆ NORMAL
- ◆ ASTRO
- ◆ OFF





17.4 Menu 2 - Configuration of opening and closing times [▲/▼] EN

NORMAL

At the configured time, a [Down]-signal will be sent to the registered DuoFern actuators.

ASTRO

The control command is sent at the daily re-calculated dusk time. The previously configured closing time is interpreted as “**latest at xx:xx hours**”.

OFF

No automatic control function is executed for [Down].

Example:

The roller shutters close at the configured closing time.

Example:

The roller shutters close at the daily re-calculated dusk time.

- 6.1. If the switching time mode was changed, a control signal will be sent automatically to all DuoFern actuators logged in.

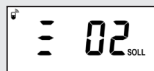

7. Set and confirm a **closing time [▼]**.

The header of the display indicates which switching time programme is currently active (see point 5.).

Factory setting = weekly switching time [MO - SO] (MON - SUN)

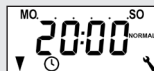

- a) If [ASTRO] is selected, then the calculated closing time for the current day is displayed.

- b) Return to main menu.

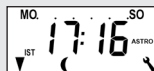

8. Return to standard display after making the final setting.





17.4 Menu 2 - Configuration of opening and closing times [▲/▼] EN

Information about the [ASTRO] switching time mode

- ◆ If [ASTRO] is selected as the switching time mode, the calculated darkness time can be individually customised by means of an offset between **-60** and **+60 minutes**.
 - Dusk can be configured in **menu 3**, see page 44.
 - Dawn can be configured in **menu 5**, see page 48.



17.5 Switch the automatic timer on/off for individual DuoFern actuators

1.	Call up the main menu.	M	
2.	Select and open menu 2 [🕒] switching times .	▲ ▼ OK	
3.	Select a DuoFern actuator.	▲ ▼ OK	
a)	Switch the automatic timer on or off for the selected DuoFern actuator.	▲ ▼	
On	= automatic timer on		
OFF	= automatic timer off		
b)	Return to main menu.	OK	

17.6 Automatic dusk function

EN

The automatic dusk function causes the roller shutters to close automatically to the lower end point or configured ventilation position. The twilight time is recalculated every day based on the geographical location and the current date (defined by the configured postcode).

17.7 Menu 3 - Customising the automatic dusk function [3]

1. Call up the main menu.

M

2. Select and open menu 3 [3] **Automatic dusk function.**

^ v
OK



3. Select and confirm the desired DuoFern actuator or [ALLE] (ALL).

^ v
OK



4. Switch the automatic dusk function on/off
On = automatic dusk function on
OFF = automatic dusk function off

^ v
OK



If only a single DuoFern actuator is selected in point 3, then the system returns to the main menu.

5. The offset function can be used to modify the calculated Astro time by +/- 60 minutes.

Configuration is only possible if the following functions have been previously configured:

- a) _____
Set the offset.

- b) _____
Return to main menu.

Point 3. = ALLE (ALL)
Switching time mode [V] = ASTRO

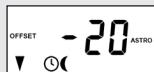

Example:

With a negative offset e.g. "- 20", the calculated Astro time is triggered 20 minutes earlier.





17.8 Automated solar function

EN

The automated solar function enables brightness-dependent control of your roller shutters. An external light sensor is required for this function (e.g. a DuoFern sun sensor).



17.9 Menu 4 - Switching the automated solar function on/off [☀]

1. Call up the main menu.

M

2. Select and open menu 4 [☀] **Automated solar function.**

^ v

OK



3. Select and confirm the desired DuoFern actuator or [ALLE] (ALL).

^ v

OK

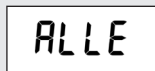

4. Activate / deactivate and confirm automated solar functions.

^ v

OK



On = automated solar functions on
OFF = automated solar functions off

- a) Subsequently the main menu will be displayed.





17.9.1 Setting the local sunshine position

EN

The sunshine position can only be configured individually for each DuoFern actuator.

Notes on sunshine position

- ◆ The **running time** must be configured prior to setting the sunshine position (see page 52).
- ◆ The locally mounted light sensor may not be covered by the roller shutters when they are moving downwards.
- ◆ Set the sunshine position in a way that the roller shutters remain above the light sensor. Otherwise the light sensor cannot correctly measure the brightness level.

1. Call up the main menu.		
2. Select and open menu 4 [☀️] Automated solar function .	 	
3. Select a DuoFern actuator.	 	
a) Switch the automated solar functions on and confirm for the selected DuoFern actuator. On = automated solar functions on OFF = automated solar functions off	 	
4. Subsequently the local sunshine position can be configured.		
a) Move the roller shutters to the desired position.	 	
b) Store the position of the sun on the DuoFern actuator and return to the main menu.		



17.10 Automatic dawn function [☀]

EN

The automatic dawn function causes the roller shutters to open automatically to the upper end point. The calculated dawn time can be customised by linking the opening times with the [ASTRO] switch time mode.



17.11 Menu 5 - Customising the automatic dawn time [☀]

1. Call up the main menu.

M

2. Select and open menu 5 [☀] dawn function.

^ v

OK



3. Select and confirm the desired DuoFern actuator or [ALLE] (ALL).

^ v

OK



4. Switching the automatic dawn function on/off.

^ v

OK



On = automatic dawn function on

OFF = automatic dawn function off



If only a single DuoFern actuator is selected in point 3, then the system returns to the main menu.



5. The offset function can be used to modify the calculated Astro time by +/-60 minutes.

Configuration is only possible if the following functions have been previously configured:

- a) Set the offset.

- b) Return to main menu.

Point 3. = ALLE (ALL)
Switching time mode [▲] = ASTRO



Example:

With a negative offset e.g. "- 20", the calculated Astro time is triggered 20 minutes earlier.





The random function enables a random delay of the set timer periods ranging between 0 and 30 minutes.

The random function is executed for:

- ◆ all automatic opening and closing times.

1. Call up the main menu.

M

2. Select and open menu 6 [] **Random function.**

^ v

OK



3. Select and confirm the desired setting.

^ v

OK



On = random function on

OFF = random function off

Subsequently the main menu will be displayed again.







This menu enables you to configure additional devices and system settings to customise your DuoFern HomeTimer to your individual preferences.

The DuoFern settings are introduced and described from page 29 onwards. The DuoFern settings are shown in menu order in menu 9.9 as shown below.



Menu 9 - System settings

Icon	Menu	Page
	9.1 Time and date.....	52
-	9.2 Motor running time.....	52
	9.3 Ventilation position.....	54
[PLZ]	9.4 Postcode.....	55
	9.5 Switching time program.....	56
[T]	9.7 Jog mode.....	57
-	9.8 Device settings	58
	9.9 DuoFern settings.....	29



18.1 Menu 9.1 - Set time and date [🕒]

EN

1. Select and open menu **9.1 - Time and date**



OK

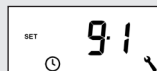

Setting order

2. Time

Pressing a setting key for an extended period causes the numbers to progress more quickly.



OK



3. Date



OK



4. Year



OK

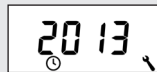

18.2 Menu 9.2 - Configure motor running time

The run time setting must be configured if:









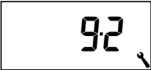

- ◆ you intend to use the ventilation position function, see page 54.
- ◆ you intend to use the position of the sun, see page 46.

The running time can be detected directly by the DuoFern HomeTimer or you may, for example, measure and configure it with the help of a stopwatch.



Important notes

- ◆ Tubular motor running times can vary depending on temperature. For this reason, targeted movement to a specific position is subject to certain tolerances.
- ◆ The running time must be configured as precisely as possible in order for the desired position to be reliably assumed.
- ◆ The running time must be reconfigured if the end points are changed.
- ◆ If the running time is configured, for example, with the help of a stopwatch, then the speed should be measured in the up direction and approx. 10% should be added.

1. Select and open menu 9.2 Motor running time .	  	
2. Select a DuoFern actuator.	  	
3. Press the [Down] button and wait until the roller shutters have travelled to the lower end point.		
4. Press the [Up] button and wait until the roller shutters have travelled to the upper end point.		
5. Release the [Up] key.		The running time will be timed and stored during the up cycle.
6. Back to system menu.		



18.2 Menu 9.2 - Configure motor running time

EN

Manually setting the running time

- Fully close the roller shutters.
- Subsequently move the roller shutters to the upper end point and make a note of the time required.
- Enter and confirm the measured running time in menu **9.2**.

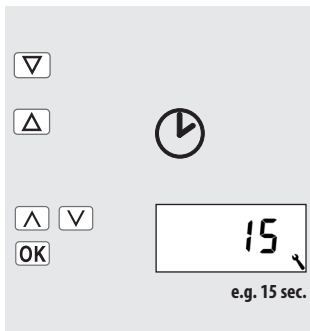

18.3 Menu 9.3 - Configure ventilation position [▼]

If you do not want the roller shutters to close fully to the lower end point, you can use this function to configure an arbitrary position (**e.g. as ventilation position**).

When closing automatically, the roller shutters will stop at the ventilation position, however, they can subsequently be closed completely via manual operation.



The running time must be configured prior to setting the ventilation position, see page 52.

- Select and open menu **9.3 - Ventilation position**.



- Select a DuoFern actuator.





18.3 Menu 9.3 - Configure ventilation position [▼]

EN

3. Activate or deactivate the ventilation position.



OK



- On** = Ventilation position on
OFF = Ventilation position off

> continue with 4.

> Return to menu system settings

4. Subsequently move the roller shutters to the desired position.

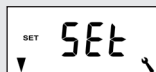

Example

5. Confirm the ventilation position and return to the system settings menu.

OK



18.4 Menu 9.4 - Set postcode [PLZ]

1. Select and open menu 9.4 - Postcode [PLZ]



OK

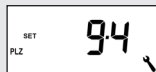

2. Set and confirm the **postcode**.



OK

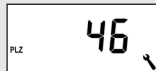

Please observe the following notes:

- ◆ Only the first two digits of the code are entered for German cities.
- ◆ Please refer to the time zone table on page 67 for various European cities.
- ◆ If the DuoFern HomeTimer is not being used in Germany, it may be necessary to switch off the automatic summer/winter clock change function. In order to do so, please refer to page 59 "Activate/deactivate automatic summer/winter time change".



18.5 Select Menu 9.5 - Switching time programme [17]

EN

The number of opening and closing times that can be configured depends on the desired **switching time programme** selected in this menu.

There are three switching time programs available:

[1] Weekly switching times (factory setting)

- ◆ One switching time pair [▲/▼] for [MO...SO] (MON...SUN)

[2] Working day and weekend switching times

- ◆ One switching time pair [▲/▼] for [MO...FR] (MON...FRI)
- ◆ One switching time pair [▲/▼] for [SA + SO] (SAT + SUN)

[3] Individual day switching times

- ◆ One switching time pair [▲/▼] for every day of the week
[MO / DI / MI / DO / FR / SA / SO] (MON / TUE / WED / THU / FRI / SAT / SUN)

1. Select and open menu **9.5 - Motor running time.**



2. Select and confirm the desired **switching time programme.**

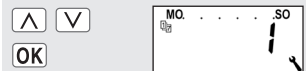

- 1 = Weekly switching times
- 2 = Weekday / weekend switching times
- 3 = Individual day switching times

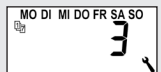
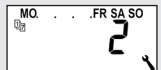

The switching times are configured in menu [2], see page 40.





18.6 Menu 9.7 - Set jog mode [T]



EN

This function enables you to use the DuoFern HomeTimer to control Venetian blinds. Briefly tapping the operating buttons enables Venetian blinds slats to be conveniently configured.

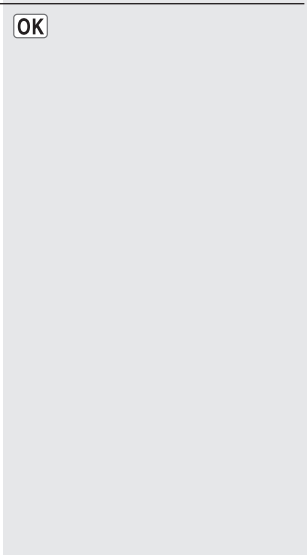
In order to conveniently move the Venetian blinds to the end points, actuate the control key [Up / Down] for at least 1 second.

1. Select and open menu 9.7 - Jog mode .	
2. Activate or deactivate jog mode . On = on OFF = off	
3. Confirm the previous setting and return to the "System settings" menu.	



Menu 9.8 - Device settings		
Icon	Menu	Page
	9.8.1 Automatic summer / winter changeover.....	59
	9.8.3 Display backlighting	59
	9.8.5 Key lock.....	60
	9.8.7 Reversal of rotation direction	61
	9.8.9 End points	62
	9.8.0 Software version	63



18.7.1 Menu 9.8.1 - Automatic summer/winter changeover on/off

EN

The DuoFern HomeTimer features an automatic summer/winter changeover function.



If the controller is not being used in Germany, it may be necessary to switch off the automatic summer / winter clock change function.

1. Select and open menu **9.8.1 Summer/winter changeover**.



OK

9.8.1 ↘

2. Activate/deactivate summer/winter changeover and confirm.



OK

On ↘

On = Function on

OFF = Function off



18.7.2 Menu 9.8.3 - Set display backlighting

Pressing one of the operating keys causes the backlighting in the display to switch on.

1. Select and open menu **9.8.3 - Display backlighting**



OK

9.8.3 ↘

2. Configure and confirm the desired brightness.



OK

2 ↘

OFF = off

1 - 3 = brightness level



The intensity of the display backlighting can vary for a number of functions because, for example, automatic changes can cause more current to be drawn from the battery.



You can activate the key lock to protect against unintentional input.

Automatic activation after approx. two minutes.

If the key lock is activated and no keys are pressed within a period of two minutes, the key lock is activated automatically.

1. Select and open menu **9.8.5 - Key lock.**

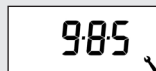

2. Activate or deactivate the key lock.

On = on

OFF = off



Press and hold the [**SET/Stop**] key for four seconds in order to remove or activate the key lock in the standard display.



approx. 4 sec.

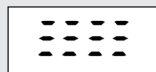

Display:

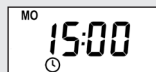

Display for active key lock.

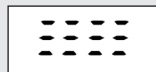

When pressing the menu key.



















The roller shutters can be moved manually, even with the key lock activated.



18.7.4 Menu 9.8.7 - Switch reversal of rotation direction on/off

EN

The **reversal of rotation direction** function can be used to change the direction of rotation if the direction of a DuoFern actuator is incorrect.

1. Select and open menu 9.8.7 - Reversal of rotation direction .	  	
2. Select a DuoFern actuator.	  	
3. Test the current direction.	 	
4. Activate or deactivate reversal of rotation direction.	  	
5. Test the new direction.	  	



18.7.5 Menu 9.8.9 - Configuration of end points for the tubular motor EN

You can use your DuoFern HomeTimer to configure the end points for an electronic RADEMACHER tubular motor.



The end point setting function is only available for RADEMACHER electronic tubular motors from 2000 onwards.

The end point setting can not be adjusted for tubular motors connected in parallel.

1. Select and open menu **9.8.9 - End points**.

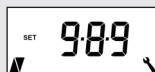

2. Select a DuoFern actuator. [**ALLE**] (**ALL**) is not possible for this function.



- a) You can send a brief test signal in order to identify the DuoFern actuator.



The actuator executes a brief movement or switching command by way of confirmation.

3. Set the **upper end point**.

- a) Press and hold the set button. The roller shutters travel upwards.



- b) Release the button as soon as the desired end point is reached.

The upper end point is thereby stored for the motor.



18.7.5 Menu 9.8.9 - Configuration of end points for the tubular motor EN

4. Set the **lower end point**.
 - a) Press and hold the set button. The roller shutters travel downwards.
 - b) Release the button as soon as the desired end point is reached.
5. Back to system menu.



The lower end point is thereby stored for the motor.



The end points will only be stored if:

- ◆ the tubular motor is allowed to run for at least four seconds before an end point is reached.
 - ◆ the configuration process is undertaken starting from the end point that is to be changed.
- Check the correct setting of the end points directly after completing the configuration process with the help of the operating keys.



18.7.6 Menu 9.8.0 - Display software version

This menu enables the current software version for the DuoFern HomeTimer to be displayed.

1. Select and open menu **9.8.0 - Software version**.
2. Subsequently the **current software version** will be displayed.
3. Back to system menu.

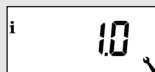
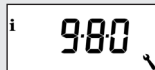



19. Software reset (restore factory settings)

EN

If necessary, you can erase all of your settings and return the DuoFern HomeTimer to its original factory settings.

1. Simultaneously press and hold all four keys for 5 seconds, until all of the icons are shown on the display.



approx. 5 sec.



2. Next, the software version will be displayed for a few seconds.
All settings will be erased and reset to the default factory settings.



3. The system returns to the installation wizard automatically after resetting. Carry out the initial settings, see page 22.

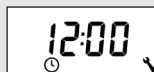

1. Carefully pull the operating unit [1] and cover frame [2] off of the wall bracket [3].

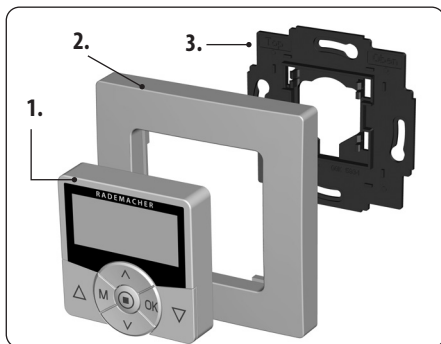
**i** 21. Simplified EU Declaration of Conformity

RADEMACHER Geräte-Elektronik GmbH hereby declares that the DuoFern HomeTimer complies with the Directive 2014/53/EU (Radio Equipment Directive).

The full text of the declaration of conformity is available at the following website:

www.rademacher.de/ce

External dimensions control unit [1]:	50 x 50 mm x 12 (according to DIN 49075)
Colour:	ultra-white / aluminium
Nominal voltage:	3 V (DC)
Battery type:	1 x CR2450
Battery life:	1.5 years with display backlighting* 3 years without display backlighting* * at five switching processes per day
Permissible ambient temperature:	5 to 40°C
Protection class:	II (only for use in dry areas)
Transmission frequency:	434.5 MHz
Transmission power:	max. 10 mW
Range:	indoors approx. 30 m* / outdoors approx. 100 m * depending on the building structure

Automatic:	On
Timer periods:	On
Up-time and mode:	7:00 hours / NORMAL
Down-time and mode:	20:00 hours / NORMAL
Random function:	OFF
Postcode:	46
Switching programme:	1
Jog mode:	OFF
Automatic summer/winter changeover	On

Belgium	134 Lyon	165 Utrecht	199 Andermatt
101 Antwerp	135 Montpellier	Norway	200 Chur
102 Bruges	136 Nantes	166 Oslo	201 Lausanne
103 Brussels	137 Nice	167 Stavanger	202 Lucerne
104 Liege	138 Paris	168 Bergen	203 Zurich
105 Mechelen	139 Reims	169 Trondheim	Sweden
106 Mons	140 Strasbourg	Austria	204 Boras
107 Ostend	141 Toulon	170 Amstetten	205 Gavle
Denmark	Italy	171 Baden	206 Göteborg
108 Aalborg	142 Bologna	172 Braunau	207 Helsingborg
109 Ringsted	143 Bolzano	173 Brixen	208 Jönköping
110 Esbjerg	144 Florence	174 Bruck/Mur	209 Östersund
111 Horsens	145 Genoa	175 Eisenstadt	210 Malmö
112 Kolding	146 Milan	176 Graz	211 Stockholm
113 Copenhagen	147 Naples	177 Innsbruck	212 Sundsvall
114 Svendborg	148 Palermo	178 Klagenfurt	213 Umea
115 Randers	149 Rome	179 Landeck	Spain
England	150 Turin	180 Linz	214 Almería
116 Aberdeen	151 Venice	181 Nenzing	215 Alicante
117 Birmingham	Ireland	182 Salzburg	216 Barcelona
118 Bristol	152 Cork	183 Vienna	217 Bilbao
119 Glasgow	153 Dublin	Poland	218 Badajoz
120 London	154 Belfast	184 Wrocław	219 Burgos
121 Manchester	Latvia	185 Bromberg	220 Cáceres
122 Newcastle	155 Riga	186 Gdansk	221 Castellón
Estonia	Liechtenstein	187 Kattowitz	222 Granada
123 Tallinn	156 Vaduz	188 Cracow	223 Guadalajara
Finland	Lithuania	189 Lodz	224 La Coruña
124 Helsinki	157 Vilnius	190 Lublin	225 Lérida
125 Jyväskylä	Luxembourg	191 Posen	226 León
126 Oulu	158 Luxembourg	192 Stettin	227 Madrid
127 Tampere	The Netherlands	193 Warsaw	228 Murcia
128 Turku	159 Amsterdam	Portugal	229 Oviedo
129 Vasa	160 Eindhoven	194 Faro	230 Palma
France	161 Enschede	195 Lisbon	231 Pamplona
130 Bordeaux	162 Groningen	196 Porto	232 San Sebastián
131 Brest	163 Maastricht	Switzerland	
132 Dijon	164 Rotterdam	197 Basle	
133 Le Havre		198 Bern	

- 233 Seville
- 234 Santander
- 235 Valencia
- 236 Valladolid
- 237 Vitoria
- 238 Zaragoza
- 239 La Palma
- 240 Tenerife
- 241 Grand
Canaria
- 242 Fuerteventura

South-east Europe

- 243 Athens
- 244 Belgrade
- 245 Bratislava
- 246 Bucharest
- 247 Budapest
- 248 Istanbul
- 249 Maribor
- 250 Prague
- 251 Sarajevo
- 252 Sofia
- 253 Skopje
- 254 Thessaloniki
- 255 Zagreb

RADEMACHER Geräte-Elektronik GmbH provides a 24-month warranty for new systems that have been installed in compliance with the installation instructions. All construction faults, material defects and manufacturing defects are covered by the warranty.

Your statutory warranty claims shall remain unaffected by this warranty.

The following are not covered by the warranty:

- ◆ Incorrect fitting or installation
- ◆ Non-observance of the installation and operating instructions
- ◆ Improper operation or wear and tear
- ◆ External influences, such as impacts, knocks or weathering
- ◆ Repairs and modifications by third parties, unauthorised persons
- ◆ Use of unsuitable accessories
- ◆ Damage caused by unacceptable excess voltage (e.g. lightning)
- ◆ Operational malfunctions caused by radio frequency overlapping and other such radio interference

A prerequisite for the warrant is that the new device must have been purchased from one of our approved specialist retailers. Proof of this must be provided by presenting a copy of the bill.

RADEMACHER shall remedy any defects, which occur within the warranty period free of charge either by repair or by replacement of the affected parts or by supply of a new replacement unit or one to the same value. There is no general extension of the original warranty period by delivery of a replacement or by repair as per the terms of the warranty.

RADEMACHER

Geräte-Elektronik GmbH
Buschkamp 7
46414 Rhede (Germany)
info@rademacher.de
www.rademacher.de

Service:

Hotline 01807 933-171*
Fax +49 2872 933-253
service@rademacher.de

* 30 seconds free of charge, subsequently 14 cents / minute from German fixed line networks and max. 42 cents / minute from German cellular networks.