

**EN Troll Comfort DuoFern**  
Instruction manual for the electrical connection and for commissioning

Item no. 3650 05 72 (ultra-white) / 3650 05 82 (aluminium)

Type: 5665





With your purchase of a **Troll Comfort DuoFern**, you have chosen a quality product manufactured by RADEMACHER. Thank you for the trust you have placed in us.

RADEMACHER products have been developed with the greatest possible convenience in mind. Having applied uncompromising quality standards and thorough testing, we are proud to be able to present this innovative product to you.

All the highly qualified employees at RADEMACHER are behind this.



<b>i</b>	<b>Dear Customer,</b> .....	<b>2</b>
<b>1.</b>	<b>This manual</b> .....	<b>7</b>
1.1	How to use this manual .....	7
<b>2.</b>	<b>Hazard symbols</b> .....	<b>8</b>
2.1	Levels of danger and signal words.....	8
2.2	Symbols and depictions used.....	9
2.3	Glossary - definition .....	10
<b>3.</b>	<b>Included in delivery</b> .....	<b>11</b>
<b>4.</b>	<b>General view of the operating unit</b> .....	<b>12</b>
4.1	General view of the installation housing.....	14
4.2	Electrical connections.....	15
4.3	Display and its symbols.....	16
<b>5.</b>	<b>Product description</b> .....	<b>18</b>
5.1	Description of the safety functions.....	20
5.2	Overview of functions .....	21
<b>6.</b>	<b>Technical specifications</b> .....	<b>23</b>
6.1	Factory settings.....	25
6.2	Conduct in the event of a power failure .....	27
<b>7.</b>	<b>Safety instructions</b> .....	<b>28</b>
7.1	Intended use .....	29
7.2	Improper use.....	30
7.3	Expert knowledge required by the installer .....	30
<b>8.</b>	<b>Safety instructions for the electrical connection</b> .....	<b>31</b>
8.1	Important information prior to the electrical connection and installation.....	33
8.2	Electrical connection.....	35
8.3	Connecting a tubular motor .....	36
8.4	Connecting a lamp .....	37
<b>9.</b>	<b>Installation after the electrical connection</b> .....	<b>38</b>

10. Brief description of the standard display and main menu .....	39
11. Introduction to opening the menus and setting the functions .....	40
12. Initial commissioning with the help of the installation wizard .....	42
13. Manual operation .....	45
14. Moving to a target position .....	46
15. Calling up and displaying weather data.....	47
16. Menu overview.....	49
17. Menu 1 - Switching automatic mode on/off.....	51
18. Switching times (opening and closing times) [▲/▼], brief description.....	52
18.1 Menu 2 - Configuring opening and closing times [▲/▼] ...	56
19. Connecting a local light sensor.....	60
19.1 Light sensor connection when using the supplied frame .	61
19.2 Light sensor connection when using a frame supplied by other manufacturers .....	62
19.3 Dismantling the light sensor.....	64
20. Automatic dusk function, brief description.....	65
20.1 Menu 3 - Customising the automatic dusk function.....	67
21. Automatic solar function, brief description .....	69
21.1 Menu 4 - Configuring the automatic solar function.....	71
22. Automatic dawn function, brief description .....	73
22.1 Menu 5 - Customising the automatic dawn time .....	74
23. Menu 6 - Configuring the random function .....	75
24. Automatic wind function, brief description .....	76
24.1 Menu 7 - Configuring the automatic wind function .....	77

<b>25. Automatic rain function, brief description .....</b>	<b>78</b>
25.1 Menu 8 - Configuring the automatic rain function.....	79
<b>26. Menu 9 - System settings .....</b>	<b>80</b>
26.1 Menu 9.1 - Setting the time and date .....	81
26.2 Menu 9.2 - Configuring the motor running time.....	82
26.3 Menu 9.3 - Configuring the ventilation position .....	84
26.4 Menu 9.4 - Setting the postcode .....	86
26.5 Menu 9.5 - Configuring the switching time programme....	87
26.6 Menu 9.6 - Configuring the blockage detection.....	89
26.7 Menu 9.7 - Setting the Venetian blind mode .....	92
<b>27. Menu 9.8 - Device settings .....</b>	<b>94</b>
27.1 Menu 9.8.1 - Switching the automatic summer/ winter time on/off .....	95
27.2 Menu 9.8.2 - Setting the display contrast.....	96
27.3 Menu 9.8.3 - Setting the permanent display lighting .....	96
27.4 Menu 9.8.3 - Setting the timer mode .....	97
27.5 Menu 9.8.5 - Switching the button lock on / off.....	98
27.6 Menu 9.8.6 - Configuring the inputs E1 / E2.....	99
27.7 Menu 9.8.7 - Switching the reversal of rotation direction on/off .....	101
27.8 Menu 9.8.8 - Configuring the light function.....	103
27.9 Menu 9.8.9 - Configuring the end points of the tubular motor .....	106
27.10 Menu 9.8.0 - Displaying the software version.....	108
<b>28. Menu 9.9 - DuoFern settings .....</b>	<b>109</b>
28.1 Menu 9.9.1 - Logging DuoFern devices on/off .....	110
28.2 Menu 9.9.2 - Setting the DuoFern mode .....	114
28.3 Menu 9.9.3 - Setting the solar mode .....	116
28.4 Menu 9.9.4 - Switching the weather data on/off .....	119
28.5 Menu 9.9.5 -Transmitting manual control commands.....	121
28.6 Menu 9.9.6 - Transferring automatic states.....	122
28.7 Menu 9.9.7 - Displaying the DuoFern address (radio code).....	123

29. Deleting all settings, software reset.....	124
30. Performing a hardware reset.....	125
31. Error messages .....	126
32. Dismantling .....	127
33. Time zone table.....	128
34. Simplified EU declaration of conformity .....	130
35. Accessories.....	130
36. Warranty terms and conditions .....	131



## 1. This manual...

EN

...describes how to install, connect the electrical system and operate the Troll Comfort DuoFern.



### 1.1 How to use this manual

- ◆ Before you begin, please read this manual through completely and follow all the safety instructions.
- ◆ Please also read the instruction manuals for the accessories (if available) as well as the manuals for the respective connected electrical appliances.
- ◆ This manual is part of the product. Please store it in an easily accessible place.
- ◆ When passing the Troll Comfort DuoFern on to a third party, this manual must be passed on as well.
- ◆ Damage resulting from non-compliance with this manual and the safety instructions will void the warranty. We assume no liability for any resulting damage.



## 2. Hazard symbols

EN

The following hazard symbols are used in this manual:



**Danger of fatal electric shock**



**Danger area / dangerous situation**



### 2.1 Levels of danger and signal words

 **DANGER!**

This hazard will lead to serious injury or death if not avoided.

 **WARNING!**

This hazard may result in serious injury or death if not avoided.

 **CAUTION!**

This hazard may result in minor or moderate injury if not avoided.

 **ATTENTION!**

This hazard may lead to property damage.





Other useful information



Please read the respective manual

1. Procedures

2.

◆ Itemisation

1) or a) Lists



Activated menu symbols and setting parameters flash on the display.

Information about opening the menus and setting the parameters can be found on page 40.



**UW**

- ◆ UW = ultra-white (device colour)

**DIN 49075**

- ◆ German Standard "Cover panels for installation devices for building into device boxes..."

**2014/53/EU**

- ◆ European Radio Equipment Directive

**ELV**

- ◆ Extra low voltage

**DuoFern**

- ◆ RADEMACHER radio system used to control compatible products.

**HomePilot®**

- ◆ The HomePilot® is a central controller unit for RADEMACHER radio products.

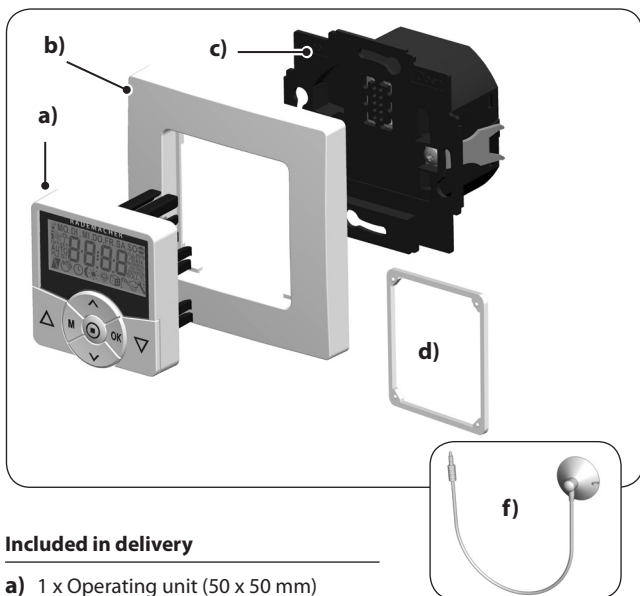

### Included in delivery

- a) 1 x Operating unit (50 x 50 mm)
- b) 1 x Frame
- c) 1 x Installation housing
- d) 1 x Spacer frame, see page 38
- e) 1 x Instruction manual (not illustrated)



### After unpacking please check and compare...



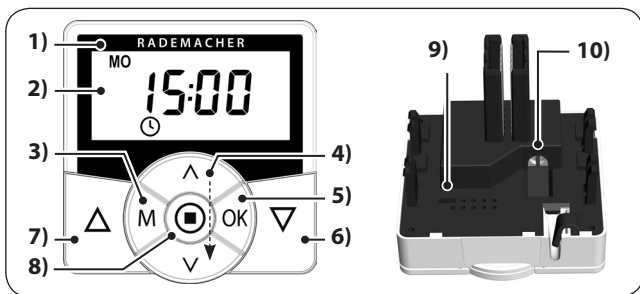

... the contents of the package with those specified above.

### Accessories optionally available, see page 130

- f) 1 x Light sensor





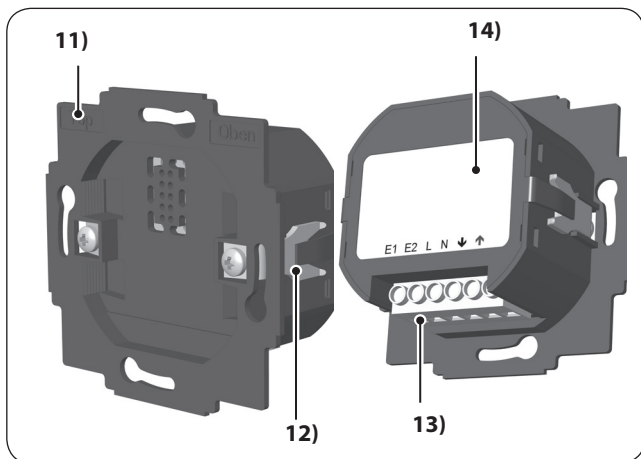

Pos.	Symbol	Description
1)		<b>Operating unit</b>
2)		<b>Display</b>
3)		<b>Menu button</b> <ul style="list-style-type: none"> <li>◆ <i>Open the main menu</i></li> <li>◆ <i>Back to the previous menu or standard display</i></li> </ul>
4)	 	<b>Setting buttons</b> <ul style="list-style-type: none"> <li>◆ <i>Select a menu in the main menu</i></li> <li>◆ <i>Set the parameters (more / less)</i> <ul style="list-style-type: none"> <li>● <i>Short press or press and hold = gradual or quick setting</i></li> </ul> </li> <li>◆ <i>Switch functions on / off (On / OFF)</i></li> <li>◆ <i>Move to a target position</i></li> <li>◆ <i>Display the various weather data sequentially</i></li> </ul>

Pos.	Symbol	Description
5)		<b>OK button</b> <ul style="list-style-type: none"><li>◆ <i>Open the selected menu</i></li><li>◆ <i>Confirm and save settings</i></li><li>◆ <i>Continue to the next setting</i></li></ul>
6)		<b>Operating buttons Up / Down</b> <ul style="list-style-type: none"><li>◆ <i>Manual operation</i></li></ul>
7)		
8)		<b>SET/Stop button</b> <ul style="list-style-type: none"><li>◆ <i>Manual stop of the roller shutter travel</i></li><li>◆ <i>Set (adjust) various functions</i></li><li>◆ <i>Call up the weather data</i></li></ul>
9)		<b>Bridging contact for a hardware reset</b> <ul style="list-style-type: none"><li>◆ <i>See page 125</i></li></ul>
10)		<b>Connection socket for the light sensor</b> <ul style="list-style-type: none"><li>◆ <i>See page 61, Installation</i></li></ul>

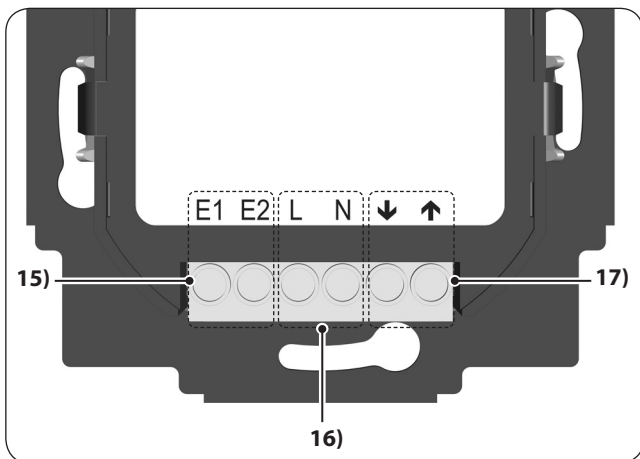





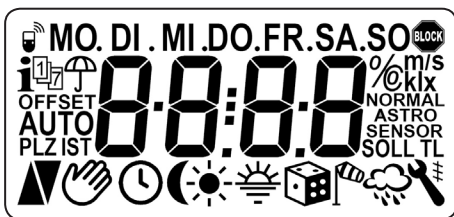

Pos.	Symbol	Description
11)		Installation housing
12)		Claw fasteners and screws
13)		Connecting terminals
14)		Type plate













Pos.	Symbol	Description
15)	E1 / E2	<b>External inputs - optional</b> Connect external signal transmitters, e.g. Venetian blind switches or Venetian blind buttons/ external sensors etc., see page 36 / 37 Both inputs are independently configured, see page 99.
16)	L / N	<b>Power supply - 230 V / 50 Hz</b>  Connect the supply voltage.
17)	 / 	<b>Rotation direction (up / down)</b> Connecting cables to the tubular motor.



Symbol	Description
MO ... SO	Weekdays (Monday ... Sunday)
88:88	Time / setting parameters
	DuoFern status
	Weather information
	Switching time programme
	Rain display
OFFSET	Offset (for astro time)
SET	Setting
AUTO	Automatic mode
PLZ	Postcode
IST	Actual value
	Direction of travel (up/down)
	Automatic mode off
	Switching times



Symbol	Description
	Automatic dusk function
	Automatic solar function
	Automatic dawn function
	Random function
	Automatic wind function
	Automatic rain function
	System settings
<b>SOLL</b>	Set value
	Automatic slat adjustment
<b>T</b>	Jog mode
<b>L</b>	Light function
<b>NORMAL</b>	Switching modes (NORMAL / ASTRO / SENSOR)
	Blockage detection
<b>%</b>	Position (in percent)
<b>°C</b>	Temperature unit in degrees Celsius
<b>m / s</b>	Wind velocity (metres per second)
<b>klx / lx</b>	Light intensity (klx = kilolux / lx = lux)
	Automatic button lock

The Troll Comfort DuoFern controller is designed for controlling roller shutters, Venetian blinds, slats or awnings by connecting a corresponding tubular motor.

If required, you can connect a lamp or other electrical appliances to the controller instead of a tubular motor and use the light function to control it.

The Troll Comfort DuoFern can be operated individually on site or it can be integrated into a DuoFern network.

**DuoFern receivers (actuators) and transmitters must be connected to the DuoFern network.**

---

You can find a detailed description of the various functions, configuration options and possible combinations for the DuoFern system at: <http://www.rademacher.de/duofern>.

**Central control of DuoFern devices with a single Troll Comfort DuoFern.**

---

A DuoFern network generally includes the DuoFern Manual Central Operating Unit or the HomePilot® (together with the associated user interface) as the central controllers.

Alternatively you can also use the Troll Comfort DuoFern as a central controller. To do so, you must configure the corresponding DuoFern mode.

**The following DuoFern modes can be selected, see page 114.**

---

[ 1 ] = DuoFern receiver

[ 2 ] = DuoFern transmitter

[ 3 ] = Local operation (factory setting)

### Roller shutter control

---

The device enables the roller shutter to be automated.

### Manual operation

---

It is possible to manually control the connected tubular motor at any time by using the controls.

### Central control of other Troll devices by cable

---

The Troll Comfort DuoFern can also be used as a central controller for other Troll devices, as an alternative to connecting a tubular motor.

You can obtain additional connection and circuit examples from our website at: [www.rademacher.de](http://www.rademacher.de)

### External control via two inputs E1 and E2

---

The Troll Comfort DuoFern features two configurable inputs E1 and E2 (230 V / 50 Hz) for connecting external signal transducers (e.g. Venetian blind switches or Venetian blind buttons / external sensors etc.), see page 36 / 37.

Both inputs are independently configured, see page 99.

### Installation and electrical connection

---

The Troll Comfort DuoFern is designed as a flush-mounted device for indoor rooms. The electrical connection is carried out by means of the connecting terminals on the reverse side of the installation housing.

### Installation / compatible switch ranges

---

The Troll Comfort DuoFern 9485 can be integrated into standard switch ranges (50 x 50 mm).



It may be necessary to use an intermediate frame \* 50 x 50 (according to DIN 49075) depending on the switch range used.

*\* Not included*

## 5.1 Description of the safety functions

---

### Blockage detection

---

The Troll Comfort DuoFern is able to monitor the torque of motors equipped with a mechanical end point setting. This enables the controller to switch off the motor in the event of overloading or blockage, see page 89.

- ◆ Display background lighting
- ◆ Installation wizard for easy commissioning
- ◆ Configurable blockage detection for mechanical tubular motors
- ◆ Manual operation on site
- ◆ Direct configuration and movement to a target position
- ◆ Switch automatic mode on/off
- ◆ Easy configuration with menu-driven operation
- ◆ Switching times
- ◆ Configurable opening [▲] and closing times [▼] for your roller shutter
- ◆ Switching time programme:
  - Weekly switching times
    - One switching time pair [▲/▼] for [MO...SO] (MON...SUN)
  - Weekday and weekend switching times
    - One switching time pair [▲/▼] for [MO...FR] (MON...FRI)
    - One switching time pair [▲/▼] for [SA + SO] (SAT + SUN)
  - Individual day switching times
    - One switching time pair [▲/▼] for every day of the week  
[MO / DI / MI / DO / FR / SA / SO] (MON / TUE / WED / THU /  
FRI / SAT / SUN)
  - Activate a second switching time block
    - Double switching times, see page 52 / 88
- ◆ Automatic dusk function
- ◆ Automatic dusk function with astro programme
- ◆ Automatic dusk function with light sensor
- ◆ Automatic solar function (with light sensor)
- ◆ Automatic dawn function with astro programme
- ◆ Random function (random delay of 0 to 30 minutes)
- ◆ Ventilation position
- ◆ End point setting

- ◆ Button lock
- ◆ Venetian blind mode
- ◆ Automatic slat adjustment
- ◆ Jog mode
- ◆ Set the running time
- ◆ Automatic wind function
- ◆ Automatic rain function
- ◆ Light function (controlling electrical appliances)
- ◆ Switch reversal of rotation direction on/off
- ◆ Automatic summer / winter changeover
- ◆ Permanent storage of the settings
- ◆ External control via the two configurable inputs E1 / E2
- ◆ Delete or reset all data

### **Description and configuration of the individual functions**

A precise description of the individual functions and settings is included starting on page 39.

### **DuoFern settings**

The settings required for operating the device in a DuoFern network are specified starting on page 109.

**Mains supply [ L / N ]**

Mains supply voltage:	230 V / 50 Hz ~
Consumption:	Standby: < 0.4 W

**2 x extension inputs [ E1 / E2 ] - configurable**

Connection of external signal transducers (Venetian blind switch or Venetian blind button / environmental sensor etc.)

Input voltage:	230 V / 50 Hz ~ (Ri = 200 kΩ)
Maximum cable length:	15 metres

**Rotation direction [ ▲ / ▼ ]**

Switching voltage:	230 V / 50 Hz ~		
Maximum switching capacity:	<table border="1" style="display: inline-table; vertical-align: middle;"> <tr> <td style="text-align: center; width: 40px; height: 40px;">M</td> <td style="padding: 0 10px;">8 (4) A μ (Type 1B)</td> </tr> </table>	M	8 (4) A μ (Type 1B)
M	8 (4) A μ (Type 1B)		

**Improper use can lead to serious injuries or property damage.**

- ◆ Due to the small contact distance (μ), not suitable for disconnecting.
- ◆ The Troll Comfort DuoFern is not suitable to be used for an electrically safe disconnection of the connected appliance.

DuoFern radio technology	
Transmission frequency:	434.5 MHz
Transmission power:	max. 10 mW
Range:	In buildings: approx. 30 m * Outdoors: approx. 100 m * <i>Depending on the building structure</i>
Maximum number of DuoFern devices:	20

General information	
External dimensions (W x H x D)	50 x 50 x 12 mm
Operating unit [ 1 ]:	according to DIN 49075
Available colours:	ultra-white (UW), glossy Aluminium
Installation depth:	32 mm
Permissible ambient temperature range:	0 °C to + 40 °C
Protection class:	II ( <i>only for use in dry rooms</i> )
Connecting terminals:	Screw terminals for max. 1.5 mm <sup>2</sup> cable cross-section
Power reserve for the timer in the event of a power failure	approx. 8 hours
<b>Setting range:</b>	<b>Light sensitivity:</b>
Automatic solar function	2000 lux to 20000 lux
Automatic dusk function	2 lux to 50 lux



Factory settings	
Automatic mode:	On
Switching times:	On
Date:	01.07.2018
Time:	12:00
Up-time and mode:	7:00 / NORMAL
Down-time and mode:	20:00 / NORMAL
Random function:	OFF
Automatic solar function:	OFF
Motor running time (2 - 255 sec.):	150 seconds
Ventilation position (1 - 99 %):	OFF / 80 %
Postcode:	34
DuoFern mode:	3 (local operation)
DuoFern solar mode:	1 (local light sensor)
Switching time programme:	1
Blockage detection:	OFF
- Motor type:	2 (45 mm / 30 Nm)
- Sensitivity:	2:30
- Reversing function:	OFF
Jog mode:	OFF
Automatic slat adjustment:	OFF
Tilting time / slat runtime: 100 - 5000 ms (0.1 to 5 sec.)	1.5 seconds (1500 ms)

Factory settings	
Standard slat position: (0 - 100% )	0%
Automatic tilt to "Down" direction after manual stop	On
Automatic tilt to sunshine position:	OFF
Automatic tilt to ventilation position:	OFF
Automatic tilt after moving to a target position:	On
Motor dead time: (0 ms / 160 ms / 480 ms)	OFF / 0 ms
Automatic summer / winter change- over:	On
Display contrast:	8
Display backlighting:	0
Timer mode:	1 (50 Hz)
Button lock:	OFF
Inputs E1 / E2:	OFF / OFF
Reversal of direction of rotation:	OFF
Light function:	OFF
Stairway function:	OFF
Stairway time (pulse duration): (100 ms - 3276 sec.)	3 minutes (180 sec.)

### **Power reserve (approx. 8 hours)**

The current time flashes for approx. 5 minutes in the event of a power failure and the Troll Comfort DuoFern changes to power reserve.

### **Time and date after a power failure**

The power reserve is approx. 8 hours. If this time is exceeded, the time and date are lost and need to be reset, see page 81.



The internal timer works with tolerances in power reserve mode. It may therefore be necessary to adjust the time after a longer power failure.

### **Data retention following a power failure**

All settings remain permanently saved. Data is not lost even after a longer power failure.



---

**The use of defective devices can lead to personal injury and damage to property (electric shocks / short circuiting).**

---

- ◆ Never use defective or damaged devices.
- ◆ Check the Troll Comfort DuoFern for damage.
- ◆ Please contact our Customer Service if you find any damage, see page 132.



---

**Improper use leads to an increased risk of injury.**

---

- ◆ Train all personnel to use the Troll Comfort DuoFern safely.
- ◆ Children must not play with the device.
- ◆ Never remove the operating unit from the installation housing during operation.

Use the Troll Comfort DuoFern only for connecting and controlling a tubular motor for roller shutters, Venetian blinds and slats as well as for electrical appliances within the permissible load limits, see page 23, Technical specifications.

The Troll Comfort DuoFern is suitable for switching the mains voltage and extra-low voltage (ELV) with basic insulation.

### Operating conditions

---

- ◆ The tubular motor must be fitted with a mechanical or electronic end position switch.
- ◆ Only operate the Troll Comfort DuoFern in dry rooms
- ◆ A 230 V/50 Hz power supply, together with a site-provided disconnecting device (fuse), must be available at the installation location
- ◆ The installation and operation of radio systems is only permitted for systems and devices where a malfunction in the transmitter or receiver would not cause a danger to persons or property or where this risk is already covered by other safety equipment.



Radio systems that transmit on the same frequency can cause interference.

Using the Troll Comfort DuoFern for purposes other than those previously mentioned is impermissible.



### **Improper use can lead to serious injuries or property damage.**

- ◆ The Troll Comfort DuoFern is not suitable to be used for an electrically safe disconnection of connected appliances.
- ◆ Never use the radio system (e.g. DuoFern radio system) and its components for the remote control of appliances and systems with increased safety-relevant requirements or where there is an accident risk. Applications of this kind require additional safety equipment. Observe the respective statutory regulations for the installation of such systems.



### **There is a risk to life caused through short circuiting and electric shocks if the Troll Comfort DuoFern is used outside or in damp rooms.**

Do not install and use the Troll Comfort DuoFern outdoors or in damp rooms.

## 7.3 Expert knowledge required by the installer

The electrical connection, installation and commissioning of the Troll Comfort DuoFern must only be carried out by a qualified electrician in accordance with the instructions in this manual.

Prior to the electrical connection, check that the voltage / frequency on the type plate corresponds to that of the local mains supply.



Follow the electrical connection specifications in the instruction manual of the tubular motor being used or that of the electrical appliance and external controller (when using E1/E2).

 **DANGER!**

**There is a risk of fatal electric shock when touching electrical components.**

- ◆ All connection and installation work must only be carried out in a de-energised state.
- ◆ Disconnect all phases of the mains power cable and secure it to prevent any reconnection.
- ◆ Check that the system is de-energised.

 **WARNING!**

**Overloading of the Troll Comfort DuoFern can lead to personal injury and destruction of the device (short circuiting).**

The maximum switching capacity must not be exceeded; please observe the details in the technical specifications, see page 23.

 **WARNING!**

**Using an incorrect installation housing can lead to personal injury and damage to property (electric shocks / short circuiting).**

- ◆ Only use the installation housing provided to connect and install the Troll Comfort DuoFern.
- ◆ Installation housings of other RADEMACHER products, such as other Troll controllers, are not compatible.

 **WARNING!**

**Connection of a second phase to E1 or E2 will cause the Troll Comfort DuoFern to be damaged.**

- ◆ When using the inputs [ E1 / E2 ], they must always be connected to the same phase [ L ] as the supply voltage.
- ◆ If another phase is connected, the incorrect mains voltage (380 V / 50 Hz) will be applied to the inputs and damage the Troll Comfort DuoFern.
- ◆ Follow the pin assignment detailed in the connection diagram.



### Setting the end points on the tubular motor

---



**You must configure the end points of the tubular motor before installing it and making the final electrical connection otherwise malfunctions may occur.**

---

It is essential that you set both end points of the tubular motor if no end points have been set yet.

### Parallel connection of electronic tubular motors

---

A maximum of 3 tubular motors can be connected in parallel to the Troll Comfort DuoFern (e.g. RADEMACHER electronic tubular motors).



In order to do so, follow the information in the instruction manual of the tubular motor being used.

### Requirements for blockage detection

---

Blockage detection is only operational if a mechanical tubular motor is connected.

### Function of inputs E1 and E2

---

Both inputs can be configured independently of each other. You can configure the functions of the inputs in menu **9.8.6**, depending on the required purpose of the connected signal transducers, see page 99.

You can obtain connection and circuit examples from our website at [www.rademacher.de](http://www.rademacher.de)

### Maximum cable length for connecting external signal transducers to E1 or E2 (e.g. Venetian blind switches or Venetian blind buttons / external sensors etc.)

---

The maximum cable length for connecting external signal transducers to E1 or E2 must be 15 metres.

### Installation materials

---

The Troll Comfort DuoFern is designed for flush-mounted installation. We recommend installation in a deep 58 mm flush-mounted box or in an electronic socket.

### Stripping length

---

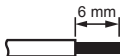

All leads must be stripped to 6 mm.

1. Ensure the mains is disconnected and check whether the mains power cables are current-free.

---

2. Securely lay all connecting cables right into the flush-mounted box.

---

3. Remove the insulation on all leads down to 6 mm in length and connect them according to the connection diagram on the following pages.

---

4. After the electrical connection, the installation of the Troll Comfort DuoFern into the flush-mounted box is carried out, see page 38.



## 8.3 Connecting a tubular motor

EN

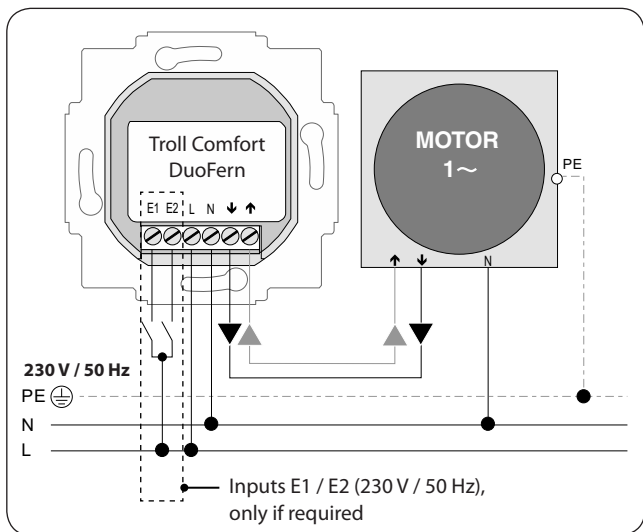

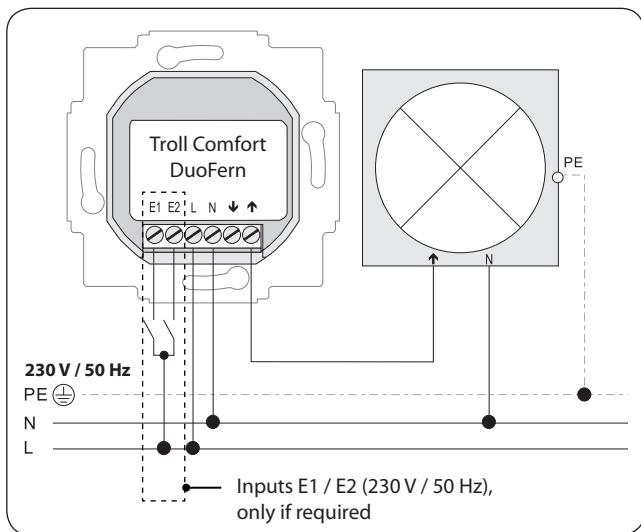

If required, you can connect a garden light (or other electrical appliances) to the controller instead of a tubular motor and use the light function to control it, see page 103, Menu **9.8.8 - Setting the light function**.

The maximum switching capacity is 500 W.

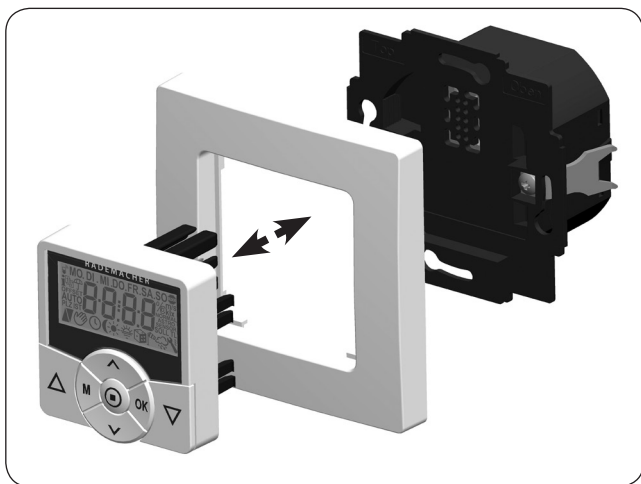

1. Insert the installation housing into the flush-mounted box and fasten it with the screws of the claw fasteners.
2. Place the frame onto the installation housing.
3. Then carefully insert the operating unit into the installation housing .
4. Switch on the mains power supply again.

### The standard display (example)

---

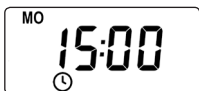

- ◆ Displays the current day of the week and time.
- ◆ Displays the activated functions.
- ◆ Manual operation of the Troll Comfort DuoFern is only possible from the standard display.

### Main menu

---



Menu number

Functions / menus

- ◆ Enables display and selection of the individual functions and menus.
- ◆ Manual operation is not possible from the main menu.
- ◆ No automatic switching commands will be executed during the configuration process.
- ◆ If no button is pressed within approx. 120 seconds, the display automatically changes from the active menu back to the standard display. Changes to settings are nevertheless saved.

1. **M**

Open the main menu.



*Pressing the menu button on the standard display opens the main menu.*

2. **^** / **v**

Select the desired menu or menu number.

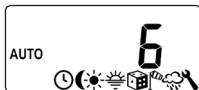

*The selected menu is indicated by a flashing symbol.*

3. **OK**

Confirm and open the selected menu.



*OFF flashes.*

4. **^** / **v**

Select the desired setting (e.g. On).





5. **OK**

Each setting must be confirmed with the OK button.



*Confirming the entry takes you to the next setting or back to the menu.*

6. **M**

Back to the standard display.

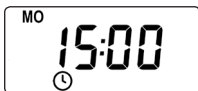

Example



Pressing the menu button briefly takes you back one menu step. Pressing and holding the button always take you to the standard display.

The installation wizard, which guides you through the first basic settings, is automatically started for the initial commissioning or after a software reset.

### Quitting the installation wizard

Pressing the **M** button for one second causes the installation wizard to be cancelled prematurely.

### Readiness for operation

The Troll Comfort DuoFern is ready for operation after completing the settings.

1. The installation wizard is shown after switching on the mains voltage. The digits start flashing.

2.  Set and confirm the current time.

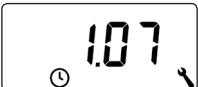
3.  Set the current date (day. month) and confirm each setting.

4.  Set and confirm the current year.

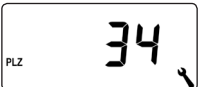
5.  Enter the first two digits of your German post-code or the desired international time zone.  
**Time zone table, see page 128.**

6.

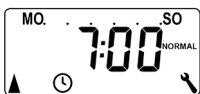

Set and confirm the opening time [▲].

**Pre-setting: MO...SO (MON...SUN)**

The opening time applies to the entire week. If necessary, you can subsequently select one of three switching time programmes in menu 9.5, see page 87.

6.1



Configure the switching time mode for the opening time [▲].

**Switching time mode**, see page 53

◆ **NORMAL**

The roller shutter opens at the configured opening time.

◆ **ASTRO**

The roller shutter opens at the daily recalculated dawn time. The previously configured opening time is interpreted as “**earliest at xx:xx hours**”.



If **ASTRO** is selected, then the opening time calculated for the current day appears after pressing the OK button.

6.2



Continue to set the closing time.

7.

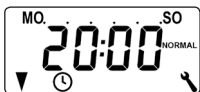

Set and confirm the closing time [▼].

**Pre-setting: MO...SO (MON...SUN)**

The closing time applies to the entire week. If necessary, you can subsequently select one of three switching time programmes in menu 9.5, see page 87.

7.1  /  > 

Configure the switching time mode for the closing time [].

**Switching time mode**, see page53

◆ **NORMAL**

The roller shutter closes at the configured closing time.

◆ **ASTRO\***

The roller shutter closes at the daily recalculated dusk time.

◆ **SENSOR\***

The roller shutter closes daily at dusk, as measured by the light sensor.

\*The previously configured closing time is interpreted as "**latest at xx:xx hours**".

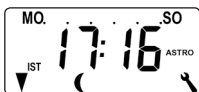

If **ASTRO** is selected, then the closing time calculated for the current day appears after pressing the OK button.

7.2 

Confirm the settings.

## 8.

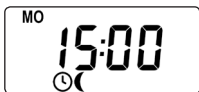

The standard display is shown after the final setting, see example.

The Troll Comfort DuoFern is now ready for operation.



You have the option of deactivating individual switching times as required. In order to do so, the value [ **OFF** ] can be selected after the value [ **23:59** ].







## 13. Manual operation

Manual operation is possible from the standard display at any time and has priority over the programmed automatic functions.

### Example for manual control of a roller shutter

---

1.  Open the roller shutter.  
Pressing the button briefly causes the roller shutter to move to the upper end point.
2.  /  or  causes the roller shutter to stop in the interim.
3.  Close the roller shutter.  
The roller shutter moves to the configured **ventilation position** or to the lower end point.

### Ventilation position, see page 84

---

If the ventilation position is configured, the roller shutter will first roll down to this position. Pressing the [ **Down** ] button once more causes the roller shutter to continue downwards.



## 14. Moving to a target position

EN

If necessary, you can enter an arbitrary target position for your roller shutter which you can then move to directly. Moving to the target position and stopping the roller shutter is done automatically.

### Automatic movement after approx. two seconds

The device will initiate movement to the configured target position automatically if no button is pressed for approx. two seconds.



In order to use this function, it is necessary to previously determine and configure the running time for the connected tubular motor, see page 82.

The ventilation position is ignored when moving to the target position.

1.  / 

Display the current position of the roller shutter by briefly pressing one of the buttons.

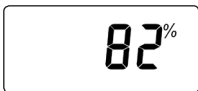



The current position is given as a percentage [%].

2.  / 

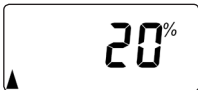
Enter the desired target position (e.g. 20%) by repeatedly pressing the button.



The arrows [/] show the resulting direction of travel.

**Value = roller shutter position**

**0 %** = fully open

**100 %** = fully closed

3. The roller shutter will automatically move to the target position and stop after approx. two seconds.



## 15. Calling up and displaying weather data

EN

The Troll Comfort DuoFern can receive and display weather data (temperature, brightness, wind velocity, rain) from a DuoFern Environmental Sensor. It is not necessary to log the DuoFern Environmental Sensor onto the Troll Comfort DuoFern.



Environmental sensors update the weather data approx. every 5 minutes and therefore it can take a few minutes until the weather data is displayed.

If no new weather data is received for 45 minutes, this is no longer available.



In the event that multiple DuoFern Environmental Sensors are being received, the desired environmental sensor can be selected in menu **9.9.4**, see page 119.



## 15. Calling up and displaying weather data

EN



As soon as an environmental sensor is detected, the corresponding symbol is shown on the display.



Pressing the SET button briefly displays the first weather data.



You can call up all the available weather data using the set buttons, see examples.

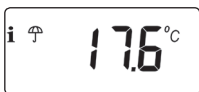

### Temperature and rain



### Brightness

0 - 999 lux = lx

1 - 150 kilo lux = klx

### Symbol depending on the brightness:

< 50 lx = (dusk)

> 50 lx =



### Wind velocity

0 - 35 m/s















Pressing the SET button briefly exits the weather data display.









The display automatically switches to the standard display after 10 seconds.



## Main menu

Symbol	Menu	Page
<b>AUTO</b>	1 Automatic mode .....	51
	2 Switching times.....	52
	3 Automatic dusk function .....	65
	4 Automatic solar function .....	69
	5 Automatic dawn function .....	73
	6 Random function .....	75
	7 Automatic wind function.....	76
	8 Automatic rain function .....	78
	9 System settings .....	80
<b>SET</b>	9.1 Time and date .....	81
	9.2 Motor running time .....	82
	9.3 Ventilation position .....	84
<b>PLZ</b>	9.4 Postcode .....	86
	9.5 Switching time programme .....	87
	9.6 Blockage detection .....	89
 T	9.7 Venetian blind mode.....	92

<b>i</b>	9.8	Device settings .....	94
	9.8.1	Automatic summer / winter changeover .....	95
	9.8.2	Display contrast .....	96
	9.8.3	Display lighting .....	96
	9.8.4	Timer mode .....	97
	9.8.5	Button lock .....	98
	9.8.6	Inputs E1/E2 .....	99
	9.8.7	Reversal of rotation direction .....	101
<b>L</b>	9.8.8	Light function.....	103
	9.8.9	End points .....	106
<b>i</b>	9.8.0	Software version .....	108
	9.9	DuoFern settings .....	109
	9.9.1	Logging on and off.....	110
	9.9.2	Setting the DuoFern mode .....	114
	9.9.3	Setting the solar mode .....	116
<b>i</b> 	9.9.4	Switching weather data on/off .....	119
	9.9.5	Transmitting manual control commands .....	121
	9.9.6	Transferring automatic states .....	122
<b>i</b> <b>IST</b>	9.9.7	Displaying the DuoFern address (radio code) ....	123



## Automatic mode on (symbol on the standard display)

- ◆ All set automatic functions are active
- ◆ Manual operation is also possible in automatic mode



## Automatic mode off (symbol on the standard display)

- ◆ All automatic functions are deactivated
- ◆ All automatic symbols are deactivated on the standard display
- ◆ Inputs E1 and E2 will not be taken into consideration - unless the automatic wind function is activated.

## Switching automatic mode on/off in menu 1

1.



Open menu 1.

2.

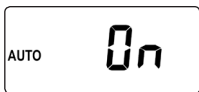

Set and confirm the desired setting.

**OFF = automatic mode off**

**On = automatic mode on**

## Toggle directly on the standard display



1 sec.

Press the OK button for one second on the standard display.



## 18. Switching times (opening and closing times) [▲/▼], brief description

**EN**

You can configure various **opening [▲] and closing times [▼]** for the Troll Comfort DuoFern in order to open or close your roller shutter automatically at your preferred times.

**For this purpose, there are three switching time programmes available in menu 9.5, see page 87:**

### [1] Weekly switching times (factory setting)

The switching times [▲/▼] apply from **(MO .... SO)** (MON...SUN).

### [2] Working day and weekend switching times

Separate switching times [▲/▼] for **(MO .... FR)** (MON...FRI) and **(SA + SON)** (SAT + SUN).

### [3] Individual day switching times

The switching times [▲/▼] can be set for every day of the week **(MO / DI / MI / DO / FR / SA / SO)** (MON / TUES / WED / THURS / FRI / SAT / SUN).

## Doubling the switching times by activating a second switching time block

If necessary you can double the number of available opening and closing times. In order to do so, a second **switching time block (n = 2)** must be activated in menu **9.5**, see page 52 / 88.

If a second switching time block has been activated [**n2**], you can select the desired switching time block [**1 or 2**] prior to setting the opening and closing times.



The switching times in the second switching time block [**2**] **cannot** be linked to a switching time mode [**NORMAL / ASTRO / SENSOR**].



## 18. Switching times (opening and closing times) [▲/▼], brief description

EN

### Application example for a second switching time

---

You can use a second switching time, for example, to darken a child's bedroom at midday:

- ◆ The **first opening time** has been set to 8:00 hours.
- ◆ The roller shutter will open at 08:00 hours
- ◆ The roller shutter should close again at 12:00 hours and open again at 14:30 hours.
- ◆ In order to do so, the **second switching time block** must be selected and the respective **second opening and closing time** must be set accordingly.
- ◆ The **first closing time** has been set to 20:00 hours.
- ◆ The roller shutter will close at 20:00 hours.

### Selecting a switching time mode

---

Various **switching time modes** can be selected when configuring the opening and closing times.

**The following switching time modes are possible:**

- ◆ **NORMAL**
- ◆ **ASTRO**
- ◆ **SENSOR (only for closing times)**

### Brief description of the switching time modes

---

- ◆ **NORMAL**  
The roller shutter moves at the configured switching time.  
For more, see next page.



## 18. Switching times (opening and closing times) [▲/▼], brief description

EN

### ◆ ASTRO

#### Calculation of the respective switching time by means of an astro programme

The opening and closing times are calculated in relation to the date and postcode. Subsequently they are linked to the previously configured switching times.

#### ● Link to the opening time [▲]

The roller shutter opens at the daily calculated dawn time. The configured **opening time** is interpreted as **“earliest at xx:xx hours”**.

#### ● Example a:

- Dawn begins at 05:00 hours.
- The opening time has been set to 07:00 hours.
- The roller shutter will open at 07:00 hours.

#### ● Example b:

- Dawn begins at 08:00 hours.
- The opening time has been set to 07:00 hours.
- The roller shutter will open at 08:00 hours.

#### ● Link to the closing time [▼]

The roller shutter closes at the daily calculated dusk time. The previously configured **closing time** is interpreted as **“latest at xx:xx hours”**.

#### ● Example a:

- Dusk begins at 17:00 hours.
- The closing time has been set to 20:00 hours.
- Your roller shutter will close at 17:00 hours

#### ● Example b:

- Dusk begins at 22:00 hours.
- The closing time has been set to 20:00 hours.
- Your roller shutter will close at 20:00 hours



## 18. Switching times (opening and closing times) [▲/▼], brief description

EN

### ◆ SENSOR (only for closing times [▼])

**The closing time is controlled by a light sensor in relation to the level of brightness.**

In addition, the measured dusk value is linked to the previously configured closing time. The configured closing time is interpreted as **"latest at xx:xx hours"**.

#### ● Example a:

- In winter dusk begins, for example, at approx. 17:00 hours.
- The closing time has been set to 20:00 hours.
- Your roller shutter will close at 17:00 hours

#### ● Example b:

- In summer dusk begins, for example, at approx. 22:00 hours.
- The closing time has been set to 20:00 hours.
- Your roller shutter will close at 20:00 hours



You have the option of deactivating individual switching times as required. In order to do so, the value [ **OFF** ] can be selected after the value [ **23:59** ].

Subsequently the switching time will not be executed (even in ASTRO or SENSOR modes).



## 18.1 Menu 2 - Configuring opening and closing times [▲/▼]

EN

If the type of switching time programme (weekly switching times, working day / weekend switching times or individual day switching times) is not to be changed, start directly with **point 2**.

1. If you want to change the type of switching time programme, first open menu **9.5**, see page 87 and configure the desired switching time programme.



- 2.



Open menu **2** if the desired switching time programme is already active.

The active switching programme is shown at the top of the display while you set the opening and closing times.

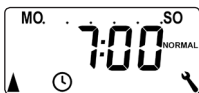

**Weekly switching times**



**Weekday / weekend switching times**

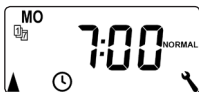

**Individual day switching times**





## 18.1 Menu 2 - Configuring opening and closing times [▲/▼]

EN

The following serves to describe the procedure for setting an **opening and closing time** [▲/▼] as **weekly switching times**.

3.

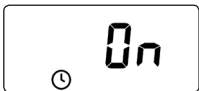

Activate and confirm the switching times.

**On** = switching times on  
**Off** = switching times off

4.

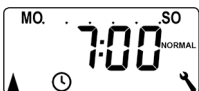

Set and confirm an **opening time** [▲].

4.1



Configure the **switching time mode for the opening time** [▲].

**Switching time mode**, see page 53

◆ **NORMAL**

The roller shutter opens at the configured opening time.

◆ **ASTRO**

The roller shutter opens at the daily recalculated dawn time. The previously configured opening time is interpreted as **"earliest at xx:xx hours"**.



If **ASTRO** is selected, then the opening time calculated for the current day appears after pressing the OK button.

4.2



Continue to set the closing time.



## 18.1 Menu 2 - Configuring opening and closing times [▲/▼]

EN

5.

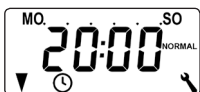

Set and confirm the closing time [▼].

5.1



Configure the switching time mode for the closing time [▼].

**Switching time mode**, see page 53

◆ **NORMAL**

The roller shutter closes at the configured closing time.

◆ **ASTRO\***

The roller shutter closes at the daily recalculated dusk time.

◆ **SENSOR\***

The roller shutter closes daily at dusk, as measured by the light sensor.

\*The previously configured closing time is interpreted as "**latest at xx:xx hours**".

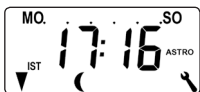

If **ASTRO** is selected, then the closing time calculated for the current day appears after pressing the OK button.

6.



Exit the settings and return to main menu.



## 18.1 Menu 2 - Configuring opening and closing times [▲/▼]

### Information about the [ASTRO] switching time mode

---

If [ASTRO] is selected as the switching time mode, the calculated dusk time can be individually customised by means of an offset between **-60** and **+60 minutes**.

- ◆ Dusk can be configured in menu **3**, see page 65.
- ◆ Dawn can be configured in menu **5**, see page 73.

### Information about the [SENSOR] switching time mode

---

If [SENSOR] is selected as the switching time mode, then the desired **dusk limit value** can be configured in menu **3**, see page 65.

If you intend to operate your Troll Comfort DuoFern and the connected tubular motor according to brightness levels, then you must connect the optionally available RADEMACHER light sensor to the Troll Comfort DuoFern.

If the Troll Comfort DuoFern is intended to react to control signals from a **central sun controller** within the DuoFern network (e.g. a DuoFern radio sun sensor), then it is not necessary to connect the local light sensor.

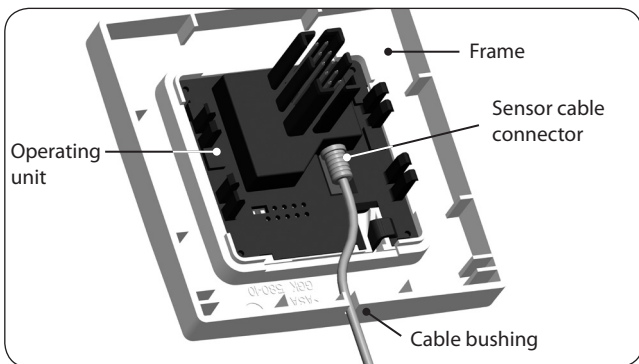

1. Carefully remove the operating unit from the installation housing.
2. Insert the light sensor connector \* into the socket on the rear of the operating unit.
3. Feed the sensor cable into the cable bushing in the frame and guide it out.
4. Carefully replace the operating unit with the frame back onto the installation housing.

\* Accessories, see page 130

### **ATTENTION!**

**Excessive bending can damage the sensor cable.**

The sensor cable is a fibre optic cable. Avoid excessive bending or crushing of the sensor cable.

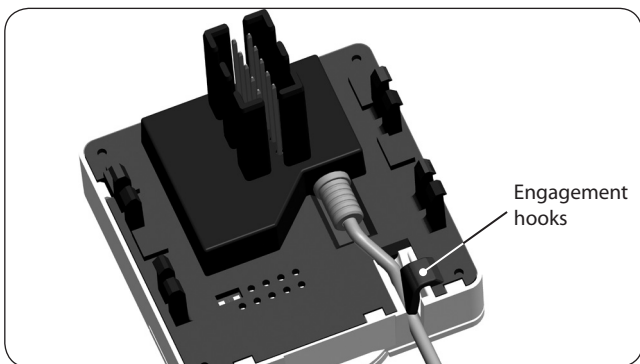

1. Carefully remove the operating unit from the installation housing.
2. Insert the light sensor connector into the socket on the rear of the operating unit.
3. Lay the sensor cable in the cable bushing of the operating unit.  
The sensor cable can be pressed into the engagement hooks with the help of a rounded object (for example, a 50 cent coin).
4. Carefully replace the operating unit together with the frame back onto the installation housing, see next page.



If the cable bushing of the operating unit is covered by the frame, then it will be necessary to fit the additionally provided spacer frame onto the rear of the operating unit.

It may be necessary to use an intermediate frame 50 x 50 \*, depending on the respective switch range used.

*\* Not included*

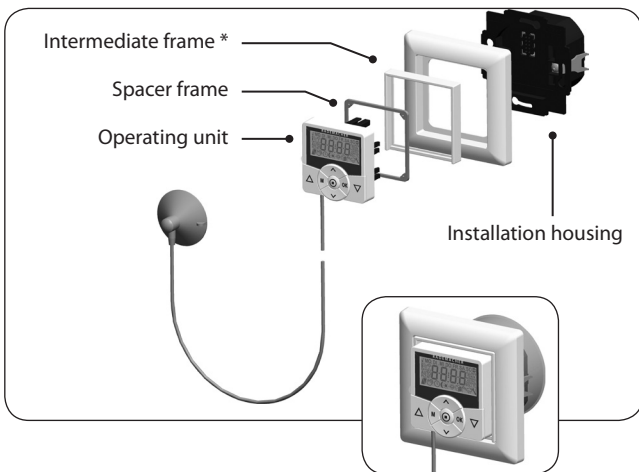

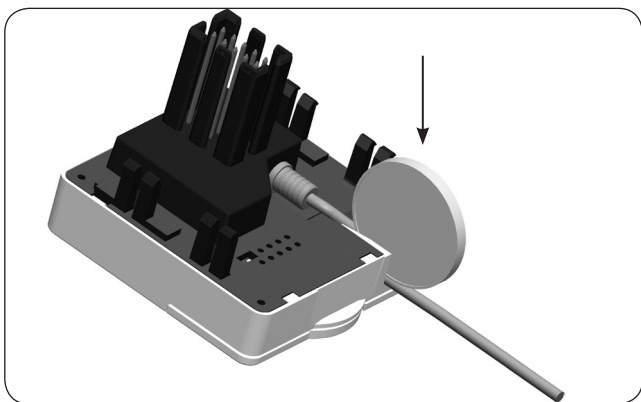

1. Carefully pull the operating unit out of the installation housing.
2. If the sensor cable has been fixed in place by means of the operating unit's engagement hooks, then it must first be released, for example, with the help of a 50 cent coin.
3. Pull the light sensor connector out of the socket.
4. Replace the operating unit back onto the installation housing.





## 20. Automatic dusk function, brief description

The automatic dusk function causes the roller shutter to close automatically to the lower end point or configured ventilation position.

**You can choose between two automatic dusk functions:**

- ◆ **Automatic dusk function with astro programme**  
= switching time mode [ **ASTRO** ]
- ◆ **Automatic dusk function with light sensor**  
= switching time mode [ **SENSOR** ]

### Automatic dusk function with astro programme

The dusk time is recalculated every day based on the geographical location and the current date (defined by the configured postcode). This means that it is not necessary to continu-

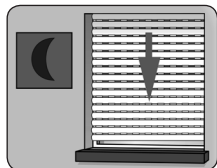

ously readjust the closing time throughout the year.

### Configuring a custom offset period

An offset can be configured between **-60 and +60 minutes** in order to customise the calculated dusk time to your personal preferences.



A light sensor is not required for this function!



## 20. Automatic dusk function, brief description

EN

### Automatic dusk function with connected light sensor

At dusk, the roller shutter will lower to the lower end limit or to the configured ventilation position after approx. 10 seconds. The roller shutter will open again once the configured opening time is reached or in the event of a manual command.

The required dusk limit value is configurable.

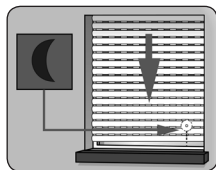

**Installation of the  
light sensor, see  
page 61.**



The automatic dusk function with a light sensor is only executed once per day.



## 20.1 Menu 3 - Customising the automatic dusk function

EN

1. Open menu 3.



2. Customise the automatic dusk function in accordance with the selected switching time mode [**NORMAL / ASTRO or SENSOR**]:

### NORMAL



No customisation is possible in this switching time mode.



Return to main menu.

### ASTRO

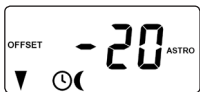

Set the offset.

The offset function can be used to modify the calculated astro time by **+/- 60 minutes**.

#### Example:

With a negative offset e.g. **- 10**, the calculated astro time is triggered 10 minutes earlier.

Subsequently the resulting closing time is displayed.

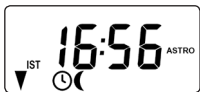

Return to main menu.



### SENSOR

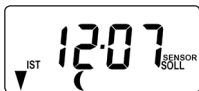

Customise the **dusk limit value** in switching time mode [ **SENSOR** ].

If the limit value is not met due to the onset of dusk, the roller shutter will close.



#### **ACTUAL value**

Currently measured brightness (e.g. 12).

- - = too bright

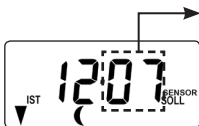

#### **SET value**

Configurable limit value

**01** = very dark, approx. 2 lux

**15** = less dark, approx. 50 lux



Return to main menu.



The automatic solar function (solar mode [ 1 ]) enables brightness-dependent control of your roller shutter. To do this, a local light sensor is secured to the window with a suction cap and then plugged into the Troll Comfort DuoFern device.

If you use external sun sensors (e.g. the DuoFern Sun Sensor or the DuoFern Environmental Sensor in conjunction with the HomePilot®) or the Troll Comfort DuoFern itself as a central sun controller for other DuoFern devices, please read further on page 116.

### Automatic solar function

Automatic movement of the roller shutter once a set limit is exceeded. The roller shutter end position can be freely selected by changing the **position of the local light sensor** on the window.

### Please note the state of the sun symbol on the standard display



When the automated solar function is active, the sun symbol flashes on the standard displays as soon as the configured set limit is exceeded.

### Automatic lowering

If uninterrupted sunlight is detected for 10 minutes, the roller shutter will descend until its shadow covers the light sensor.

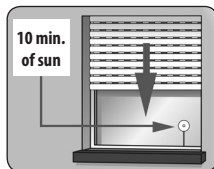

### Automatic clearing

After approx. 20 minutes, the roller shutter is automatically raised a small amount to uncover the sensor. If the sun continues to shine, then the roller shutter remains in this position.

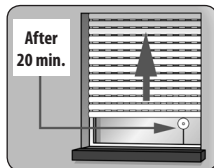



### Automatic opening

---

If the brightness decreases below the configured set limit value, the roller shutter will return to the upper end point.



The above-mentioned delay times can be exceeded in the event of changing weather conditions.

**The automatic solar function will be terminated and must be reactivated if required after the following events:**

---

- ◆ After manual actuation.
- ◆ After execution of an automatic function.
- ◆ After the upper end point is reached.



## 21.1 Menu 4 - Configuring the automatic solar function

EN

1. Open menu 4.



2. Activate and confirm the automated solar function.



**On** = automatic solar function on  
**Off** = automatic solar function off

3. Adjust the **local sun limit value**.



Configure the **local sun limit value**:

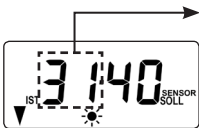

### **ACTUAL value**

Currently measured brightness (e.g. 31).

-- = too dark



### **SET value**

Configurable set limit:

**31** = minimal sun, approx. 2000 lux

**45** = bright sunlight, approx. 20000 lux



Return to main menu.



### Sunshine position for activated automatic slat adjustment

If you have activated automatic slat adjustment in menu **9.7**, you must set an arbitrary sunshine position on your Troll Comfort DuoFern manually which your roller shutter should lower to when the automated solar function is activated.



The **running time** must be configured prior to setting the sunshine position, see page 82.

#### Information about the sunshine position

- ◆ The locally mounted light sensor may not be covered by the roller shutter when it is moving downwards.
- ◆ Set the sunshine position in a way that the roller shutter remains above the light sensor. Otherwise the light sensor cannot correctly measure the brightness level.

#### 4. Configure the **local sunshine position**.



Move the roller shutter to the desired position.

or



The arrow [▼] indicates the direction of travel.



Enter the desired sunshine position, e.g. 50 %.

**Value = roller shutter position**

**0 %** = fully open

**100 %** = fully closed



Confirm the sunshine position and return to main menu.





## 22. Automatic dawn function, brief description

The automatic dawn function causes the roller shutter to open automatically to the upper end point.

When configuring opening times [▲], **it is possible to link them to a switching time mode, see page 53.** The calculated dawn time can be customised by linking the opening times with the [ASTRO] switching time mode. This means that it is not necessary to continuously readjust the opening time throughout the year.

### Link to the opening time [▲]

The previously configured opening time is interpreted as **“earliest at xx:xx hours”**.

### Configuring a custom offset period

The calculated dawn time can be customised to personal preferences by means of an offset between **-60 and +60 minutes**. An application example for the [ASTRO] switching time mode is included on page 54.



1. Open menu 5.



2. Customise the dawn time in accordance with the selected switching time mode:

### NORMAL

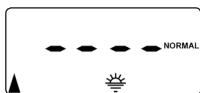

No customisation is possible in this switching time mode.

**OK** Return to main menu.

### ASTRO



Set the offset.

The offset function can be used to modify the calculated astro time by +/- **60 minutes**.

#### Example:

With a negative offset e.g. - **10**, the calculated astro time is triggered 10 minutes earlier.

Subsequently, the resulting opening time is displayed.



**OK** Return to main menu.



## 23. Menu 6 - Configuring the random function

EN

The random function enables a random delay of the set timer periods ranging between 0 and 30 minutes.

### The random function is executed for:

All automatic opening and closing times.

### Please note the state of the cube symbol on the standard display



The cube symbol flashes on the standard display when the random function is activated during the period in which the movement command is being delayed.

1.

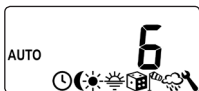

Open menu **6**.

2.



Select and confirm the desired setting.

**On** = random function on

**Off** = random function off

Subsequently the main menu will be displayed again.



## 24. Automatic wind function, brief description

EN

This function enables you to use the Troll Comfort DuoFern to operate, for example, connected Venetian blinds in relation to the weather conditions.

As soon as an external signal transducer detects “**wind**”, it can transmit the control signal to the Troll Comfort DuoFern in the **DuoFern network** or via one of the correspondingly configured inputs (**E1 or E2**).

### Configuration of inputs E1 / E2

See page 99, menu **9.8.6**

### The direction of rotation in the event of wind can be configured.

The wind can be used to retract the Venetian blinds or close them as a draught stop.



### If the automatic wind function is active ...

- ◆ The wind symbol flashes.
- ◆ Manual operation is no longer possible.
- ◆ Automatic movement commands are no longer carried out but will be resumed as soon as the wind subsides. In each case, only the last automatic movement command is subsequently executed.



In manual mode, the automatic wind function remains active, for example, in order to keep an awning protected from wind at all times.



If the rotation direction for wind is set to **DOWN** and wind is detected when the drive is at the upper end position, then the drive moves back to the upper end position as soon as no more wind is detected.



## 24.1 Menu 7 - Configuring the automatic wind function

EN

### ATTENTION!

The following settings may only be undertaken when the wind is still in order to prevent damage to the awnings / Venetian blinds.

1. Open menu 7.



2. Select and confirm the desired setting.



**On** = automatic wind function on  
**Off** = automatic wind function off

3. Configure and confirm the **rotation direction in the event of wind.**



**1** = up (factory setting)  
**2** = down

Subsequently the main menu will be displayed again.



## 25. Automatic rain function, brief description

EN

This function enables you to use the Troll Comfort DuoFern to operate, for example, a connected awning in relation to the weather conditions.

As soon as an external signal transducer detects "rain", it can transmit the control signal to the Troll Comfort DuoFern in the **DuoFern network** or via one of the correspondingly configured inputs (**E1 or E2**).

### Configuration of inputs E1 / E2

See page 99, menu **9.8.6**

### The direction of rotation in the event of rain can be configured.

The awning can be retracted (**up**) or used as a rain cover (**down**) in the event of rain.



### Once the automatic rain function is active ...

- ◆ The rain symbol flashes.
- ◆ Manual operation is still possible.
- ◆ Automatic movement commands are no longer carried out but will be resumed as soon as the rain subsides. In each case, only the last automatic movement command is subsequently executed.



The automatic rain function is also switched off in manual mode.



If the rotation direction for rain is set to **down** and rain is detected when the drive is at the upper end position, then the drive moves back to the upper end position as soon as no more rain is detected.



## 25.1 Menu 8 - Configuring the automatic rain function

EN

### ATTENTION!

The following settings may only be undertaken in dry weather in order to prevent damage to the awnings / Venetian blinds.

1. Open menu **8**.

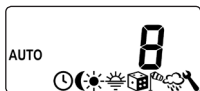

2. Select and confirm the desired setting.

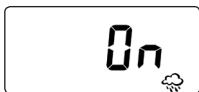

**On** = automatic rain function on  
**Off** = automatic rain function off

3. Configure and confirm the **rotation direction in the event of wind**.

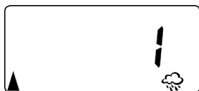

**1** = up (factory setting)  
**2** = down





Subsequently the main menu will be displayed again.



This menu enables you to configure additional devices and system settings to customise your Troll Comfort DuoFern to your individual preferences.

The DuoFern settings in menu **9.9** are introduced and described separately from page 109 onwards.



### Menu 9 - System settings

Symbol	Menu	Page
<b>SET</b>	9.1 Time and date .....	81
	9.2 Motor running time .....	82
<b>▼</b>	9.3 Ventilation position .....	84
<b>PLZ</b>	9.4 Postcode .....	86
	9.5 Switching time programme .....	87
	9.6 Blockage detection .....	89
 <b>T</b>	9.7 Venetian blind mode.....	89
	9.8 Device settings .....	94
	9.9 DuoFern settings .....	109

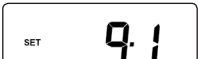

1.  Open menu **9.1**.  
Configure and confirm the desired settings.

### Setting order:

2.  Time
3.  Date  
**Day.Month**
4.  Year  
**2000 to 2099**



Configuring the running time allows specific targeted positions to be assumed based on the running time and roller shutter position.

### **The run time setting must be configured if:**

- ◆ You intend to use the ventilation position function, see page 84.
- ◆ You intend to use the sunshine position function (only if automatic slat function is activated, see page 92).
- ◆ You intend to configure and move to any target position , see page 46.

The running time can be detected directly with the Troll Comfort DuoFern or you may, for example, measure and configure it with the help of a timer.

### **Measurement information and run time setting:**

- ◆ Tubular motor running times can vary depending on temperature. For this reason, targeted movement to a specific position is subject to certain tolerances.
- ◆ The running time must be configured as precisely as possible in order for the desired positions to be reliably assumed.
- ◆ The running time must be reconfigured if the end points are changed.
- ◆ If the running time is configured, for example, with the help of a timer, then the speed should be measured in the up direction and approx. 10% should be added.



1. Open menu **9.2**.

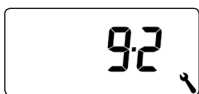

### Measuring the running time directly with the Troll Comfort DuoFern:



2.  Press the button until the roller shutter stops at the lower end point.

3.  Press the button until the roller shutter stops at the upper end point and then release it again.  
The running time has been measured and stored during the up cycle.

4.  Back to system menu.

### Measuring the running time manually:

1.  Fully close the roller shutter.

2.  >>  Subsequently move the roller shutter to the upper end point and measure the time required.

3. Enter and confirm the measured running time (e.g. 15 sec.) in menu **9.2**.

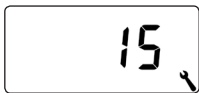



## 26.3 Menu 9.3 - Configuring the ventilation position

EN

If you do not want the roller shutter to close fully to the lower end point, you can use this function to configure an arbitrary position (**e.g. as the ventilation position**).

When closing automatically, the roller shutter will stop at the ventilation position, however, it can subsequently be closed completely via manual operation.



The running time must be configured prior to setting the ventilation position, see page 82.

1.

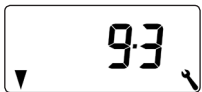

Open menu **9.3**.

2.

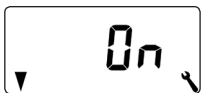

Activate / deactivate the ventilation position and confirm.

**On = ventilation position on \***

**Off = ventilation position off \*\***

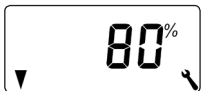

\* After activation, the current ventilation position appears.

\*\* After deactivation the display jumps back to the menu.

3.



First fully open the roller shutter.



4.  / 

or

 / 



Then move the roller shutter to the desired position.

Enter the desired ventilation position manually.

**Value = roller shutter position**

**0 %** = fully open

**100 %** = fully closed



If the position is set to **0 % or 100 %**, then the ventilation position will be deactivated.

5. 

Finally, confirm the ventilation position.

1. Open menu **9.4**.

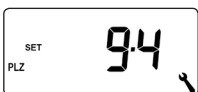

2. Enter the first two digits of your German post-code or the desired international time zone.

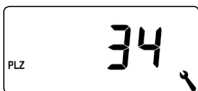

**Time zone table, see page 128.**

**34 = factory setting**



If the Troll Comfort DuoFern is not being used in Germany, it may be necessary to switch off the automatic summer/winter changeover function. In order to do so, please refer to page 95 "**Activating/deactivating the summer/winter changeover**".

The number of opening and closing times that can be configured depends on the desired switching time programme selected in this menu.

### There are three switching time programmes available:

---

#### [ 1 ] Weekly switching times (factory setting)

The switching times [▲/▼] apply from **(MO .... SO)** (MON...SUN).

#### [ 2 ] Working day and weekend switching times

Separate switching times [▲/▼] for **(MO .... FR)** (MON...FRI) and **(SA + SON)** (SAT + SUN).

#### [ 3 ] Individual day switching times

The switching times [▲/▼] can be set for every day of the week **(MO / DI / MI / DO / FR / SA / SO)** (MON / TUES / WED / THURS / FRI / SAT / SUN).

### Doubling the switching times [▲/▼] by activating a second switching time block:

---

If you want to double the number of opening and closing times, then you must activate a second **switching time block (n = 2)** here.

After this has been activated, you can subsequently configure opening and closing times for both switch time blocks, see page 52.

1.



Open menu **9.5**.

2.

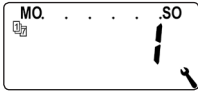

Select and confirm the desired week programme.

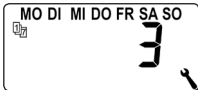

3.

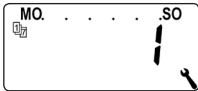

Configure and confirm the number of **switching time blocks**.

**n1 = one switching time block is active \***  
**n2 = two switching time blocks are active**

\* Recommended setting



The switching times [▲/▼] are configured in menu **2**, see page 56.



The Troll Comfort DuoFern is able to monitor the torque of motors equipped with a mechanical end point setting. This enables the controller to switch off the motor in the event of overloading or blockage. As a result, the roller shutter is protected from damage.



**Blockage detection** can only be used in combination with a tubular motor **with mechanical end point setting**.

1.

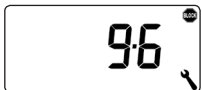

Open menu **9.6**.

2.

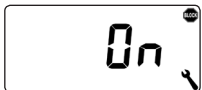

Activate/deactivate the blockage detection and confirm.

**On = blockage detection on \***

**Off = blockage detection off \*\***

\* Continue with point 3.

\*\* After deactivation and confirmation the display jumps back to the menu.

3.

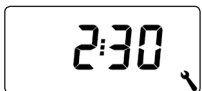

Select and confirm the suitable motor type.

**A list of the motor types is provided on the following page.**



Please also read the instruction manual for the tubular motor being used.

Motor types	Ø	Power
1:06	35 mm	6 Nm
1:10	35 mm	up to 10 Nm
2:10	45 mm	up to 10 Nm
2:20	45 mm	up to 20 Nm
2:30	45 mm	up to 30 Nm
2:40	45 mm	up to 40 Nm
2:50	45 mm	up to 50 Nm

If the installed motor type is unknown, please select:

**1:06** for roller shutters with an area of up to 1.5 m<sup>2</sup>

**2:30** for larger roller shutters

4.

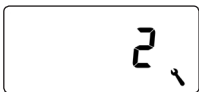

Set and confirm the sensitivity.

**Sensitivity:**

**1 = low**

**6 = high**



Test runs should be made to ascertain the highest possible sensitivity in order to protect the roller shutter in the event of blockage.



It may be necessary to customise the **cut-off sensitivity** depending on the properties of the roller shutter (weight, running characteristics etc.).

5.



Activate/ deactivate the **reversing function** after a blockage is detected.

**On = reversing function on**

**Off = reversing function off**

### Automatic reversing function in the event of a blockage

---

In the event of a blockage, the motor immediately runs in the opposite direction for approx. 2 seconds to release the roller shutter.

#### More information about the blockage detection:

- ◆ If longer connecting leads are used (>5 m), it is possible that the blockage detection system will fail to work correctly due to external interference.
- ◆ It is possible that the motor will be switched off by the blockage detection system when moving out of the end points when using mechanical motors with high switching hysteresis. Blockage detection must be deactivated for this type of motor.



Some motors can trigger undesired reversing when reaching the end positions (e.g. atypical internal motor wiring, long cables etc.). In such cases it is recommended to deactivate the reversing function.



If the motor type cannot be precisely determined, then a suitable setting for motor type and sensitivity must be determined by trial and error.

This function enables you to use the Troll Comfort DuoFern to control Venetian blinds.

### **The following configurations are possible:**

- ◆ Jog mode
- ◆ Automatic slat adjustment
- ◆ Tilting time

### **Additional Venetian blind functions can be configured, for example, with a HomePilot®:**

- ◆ Standard slat position
- ◆ Automatic tilt to "Down" direction after manual stop
- ◆ Automatic tilt to sunshine position
- ◆ Automatic tilt to ventilation position
- ◆ Automatic tilt after moving to a target position
- ◆ Slat runtime and motor dead time

### **Brief description of jog mode**

Tapping the operating buttons briefly enables Venetian blind slats to be conveniently configured.

In order to conveniently move the Venetian blinds to the end points, actuate the control button for 1 second longer than the configured tilting time. Once the button is released, the Venetian blinds will move to the end point without stopping.

### **Brief description of the automatic slat adjustment function**

If the Troll Comfort DuoFern controls the motor in the **down direction** until the total running time has elapsed or the Venetian blind motor is stopped manually, then the motor reverses automatically for a brief period (automatic slat adjustment function). This serves to position the slats to the desired angle in order to provide sun shading to the room.

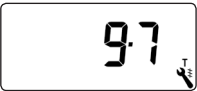
1.  Open menu **9.7**.

---

2.  Activate or deactivate the jog mode and confirm.  
**On = jog mode on**  
**Off = jog mode off**

---

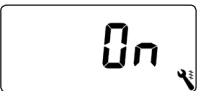
3.  Activate or deactivate the automatic slat adjustment function and confirm.  
**On = automatic slat adjustment function on \***  
**Off = automatic slat adjustment function off \*\***  
  
\* Continue with point 4.  
\*\* After deactivation and confirmation the display jumps back to the menu.



---

4.  Configure and deactivate the tilting time.  
**Setting range:**  
**Off or**  
**0.1 to 5.00 seconds**

---

5.  Confirm the last setting and return to the menu.

**Menu 9.8 - Device settings**

<b>Symbol</b>	<b>Menu</b>	<b>Page</b>
	9.8.1 Automatic summer / winter changeover .....	95
	9.8.2 Display contrast .....	96
	9.8.3 Display lighting .....	96
	9.8.4 Timer mode .....	97
	9.8.5 Button lock .....	98
	9.8.6 Inputs E1/E2 .....	99
	9.8.7 Reversal of rotation direction .....	101
<b>L</b>	9.8.8 Light function.....	103
	9.8.9 End points .....	106
<b>i</b>	9.8.0 Software version .....	108



## 27.1 Menu 9.8.1 - Switching the automatic summer/winter time on/off

EN

The Troll Comfort DuoFern features an automatic summer/winter changeover function.

### Summer time

---

The timer is changed to summer time on the last Sunday in March. The timer is set back one hour at 02:00 hours.

### Winter time

---

The timer is changed to winter time (standard time) on the last Sunday in October. The timer is set back one hour at 03:00 hours.

### Recommendation for operating the device outside Germany

If the Troll Comfort DuoFern is not being used in Germany, it may be necessary to switch off the automatic summer/winter changeover function.

1. Open menu **9.8.1**.

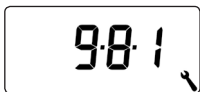

2. Activate or deactivate the summer/winter changeover function and confirm.



**On = function on**  
**Off = function off**



## 27.2 Menu 9.8.2 - Setting the display contrast

EN

1. Open menu **9.8.2**.

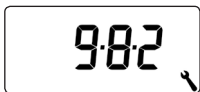

2. Set and confirm the desired contrast.



**1 = low contrast**  
**10 = high contrast**



## 27.3 Menu 9.8.3 - Setting the permanent display lighting

Pressing one of the operating buttons switches the background lighting on the display on and off after a predetermined time.

- ◆ After 10 seconds on the standard display
- ◆ After approx. 1 minute in the menus

You can set the desired brightness level if the background lighting should remain permanently lit up in an idle state (without pressing a button):

1. Open menu **9.8.3**.

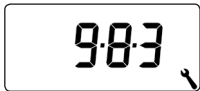

2. Set and confirm the desired brightness levels.



**0 = Deactivate the permanent display lighting**  
**1 = low brightness**  
**2 = average brightness**  
**3 = maximum brightness**





## 27.4 Menu 9.8.3 - Setting the timer mode

EN

This menu enables you to configure the time base for the internal timer (depending on the local power supply).

1.

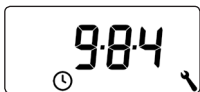

Open menu **9.8.3**.

2.

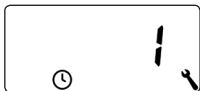

Set and confirm the desired timer mode.

**1 = 50 Hz operation (factory setting)**

e.g. in Europe

**2 = 60 Hz operation**

e.g. in the USA

**3 = Quartz timer**

for other mains frequencies



You can activate the automatic button lock to protect against any unintentional input.

1. Open menu **9.8.5**.

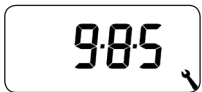

2. Activate/deactivate the button lock and confirm.

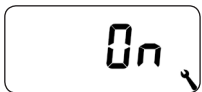

**On** = button lock on  
**Off** = button lock off

### Automatic activation after approx. two minutes

If the button lock is activated and no buttons are pressed within a period of two minutes, the button lock is switched on automatically.

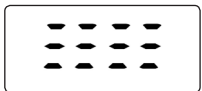

If an attempt is made to call up the menu when the button lock is active, the display flashes.

### The button lock is deactivated manually on the standard display

-  4 sec. Press and hold for 4 seconds.

### The button lock is activated manually on the standard display before the time limit expires

-  4 sec. Press and hold for 4 seconds if you want to activate the automatic button lock before the two minutes expire.



Manual operation of the Troll Comfort DuoFern is also possible when the button lock is active.



### External control via two inputs E1 and E2

---

The Troll Comfort DuoFern features two configurable inputs E1 and E2 (230 V / 50 Hz) for connecting external signal transducers (e.g. Venetian blind switches or Venetian blind buttons / environmental sensors etc.).

### The following configurations are possible:

---

- [0] Off
- [1] UP (roller shutter mode)
- [2] DOWN (roller shutter mode)
- [3] UP (Venetian blind mode)
- [4] DOWN (Venetian blind mode)
- [5] UP / Stop / Down
- [6] Automatic mode on/off (closer, NO)
- [7] Automatic mode on/off (opener, NC)
- [8] External wind signal, NO
- [9] External rain signal, NO



If manual mode is active, the inputs are not taken into consideration by the controller (except in the case of the wind function).



Both inputs can be configured independently of each other.



## 27.6 Menu 9.8.6 - Configuring the inputs E1 / E2

EN

1. Open menu **9.8.6**.

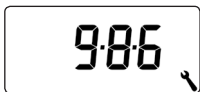

2. Set and confirm the function for input 1 (**E1**).

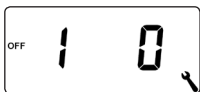

3. Set and confirm the function for input 2 (**E2**).

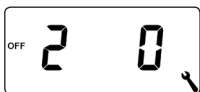

You can obtain application examples for inputs E1 / E2 from our website at: [www.rademacher.de](http://www.rademacher.de)



## 27.7 Menu 9.8.7 - Switching the reversal of rotation direction on/off

EN

It is not necessary to re-wire the motor if the direction of rotation of the connected motor is wrong ([UP] button moves the roller shutter downwards and [Down] button moves the roller shutter upwards). The direction of the motor can be easily changed using the **reversal of rotation** direction function.

### Changing the rotation direction of the logged-on DuoFern devices

You can also reverse the rotation direction of the logged-on DuoFern devices.

1. Open menu **9.8.7**.

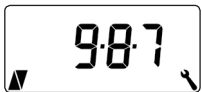

2. Select the device on which the rotation direction is to be reversed.

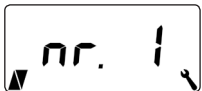

**1 = Troll Comfort DuoFern (this device)**

**2 to n = All logged-on devices in the order of logging on**

Battery-operated devices, such as a DuoFern Manual Transmitter, are not listed.

- 2.1  Check which device has currently been selected.

**Tubular motors** run for a short time.

**Switch actuators** briefly switch on/off.

3.  Confirm the selected device.









## 27.7 Menu 9.8.7 - Switching the reversal of rotation direction on/off

EN

3.1 These two displays appear alternately on the display.



4.  /  /  Briefly check the rotation direction or switching sequence of the selected device.

5.  /  >  Change and confirm the rotation direction or switching sequence as required.

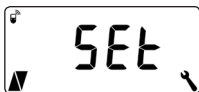

After successfully reversing the rotation direction, **SEt** flashes on the display.

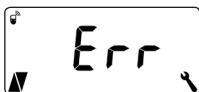

Error display if a selected device is not accessible via radio.



If a switch actuator connected via DuoFern is selected, the reversal of rotation direction corresponds to the light or device mode, see table on page 104.



The light function makes it possible to control a connected light (or other electrical appliance) instead of a roller shutter motor with the help of the automated functions.

In addition, it is also possible to manually control the light with the buttons [ **Up / Down and SET/Stop** ].

### **The underlying functions of the Troll Comfort DuoFern change when the light function is activated.**



---

When a lamp (or other electrical appliance) is controlled instead of a motor, the following motor-related functions on the Troll Comfort DuoFern are meaningless and no longer function:

- ◆ Running time
- ◆ End point setting
- ◆ Jog mode
- ◆ All Venetian blind functions
- ◆ Automatic wind and rain functions
- ◆ Sunshine and ventilation position



## Comparison of functions in light and device mode

Command / signal	Light function off	Light function on	
	Tubular motor mode	Light mode Reversal of rotation direction = <b>off</b>	Device mode Reversal of rotation direction = <b>on</b>
	Up	Off	On
	Stop	Off	Off
	Down	On	Off
Dusk	Down	On	Off
Dawn	Up	Off	Off
Sun	Down	Off	No function





1.

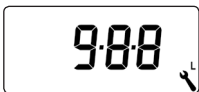

Open menu **9.8.8**.

2.

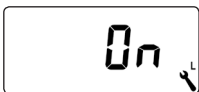

Activate/deactivate the light function and confirm.

**On** = light function on

**Off** = light function off

### Selection between the light and device function

When the light function is activated, a selection can be made between the [**light mode**] and [**device mode**] in menu **9.8.7 Reversal of rotation direction**, see page 101.



If the light function is changed, all of the logged-on DuoFern devices must be logged on again as the device type of the Troll Comfort DuoFern will also change in this case.



## 27.9 Menu 9.8.9 - Configuring the end points of the tubular motor



EN

You can use your Troll Comfort DuoFern to configure the end points of a connected electronic RADEMACHER tubular motor.

- ◆ [SET] is additionally displayed during the active end point setting process.
- ◆ The end point function is only available for RADEMACHER electronic tubular motors from 2000 onwards.
- ◆ The end point setting cannot be adjusted for tubular motors connected in parallel.
- ◆ The end point function is not available when the light function is activated, see page 103.

### **The end points will only be stored if:**

---

- ◆ The tubular motor is allowed to run for at least four seconds before an end point is reached.
- ◆ The configuration process is undertaken starting from the end point that is to be changed.
- ◆  /  Check the correct setting of the end points directly after completing the configuration process with the help of the operating buttons.





## 27.9 Menu 9.8.9 - Configuring the end points of the tubular motor

EN

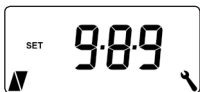
1. Open menu **9.8.9**.



2.  /  /  Allow the tubular motor to run for approx. 2 seconds to enable the connected motor type to be detected:

### Possible displays:

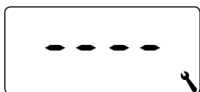

The tubular motor type has not been detected.  
**No** end point setting is possible.

 Return to menu.

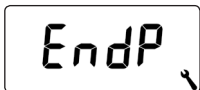

The motor type has been detected, continue with the end point settings.

3. **Setting the upper end point.**



Press and hold the button. The roller shutter travels upwards.

- 3.1 Release the button as soon as the desired end point is reached.  
The upper end point is stored in the tubular motor.

4. **Setting the lower end point.**



Press and hold the button. The roller shutter travels downwards.

- 4.1 Release the button as soon as the desired end point is reached.  
The lower end point is stored in the tubular motor.

5.  Return to menu.



## 27.10 Menu 9.8.0 - Displaying the software version

EN

This menu enables the current Troll Comfort DuoFern software version to be displayed.

1. Open menu **9.8.0**.

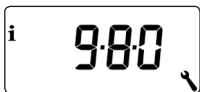

2. The current software version is subsequently displayed.

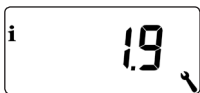

3. Display the device version.

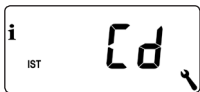

**Cd** = "Troll" Comfort DuoFern

4. Perform a display test.



5. Return to menu **9.8** - Device settings.





In order for your Troll Comfort DuoFern to be able to receive control signals from the DuoFern network or send control commands to the DuoFern network, it is necessary to log each desired DuoFern device (e.g. DuoFern actuator etc) onto the Troll Comfort DuoFern.



To do so, please also read the operating manual of the respective DuoFern device.

### Maximum number of logged-on devices

You can assign a maximum of 20 DuoFern devices to a single Troll Comfort DuoFern.

Additional information about logging on can be obtained from the "log-on matrix" on our website at:

**[www.rademacher.de](http://www.rademacher.de)**

#### Menu 9.9 - DuoFern settings

Symbol	Menu	Page
	9.9.1 Logging on and off.....	110
	9.9.2 Setting the DuoFern mode .....	114
	9.9.3 Setting the solar mode .....	116
	9.9.4 Switching weather data on/off .....	119
	9.9.5 Transmitting manual control commands .....	121
	9.9.6 Transferring automatic states .....	122
	9.9.7 Displaying the DuoFern address (radio code) ....	123



1. Open menu **9.9.1**.

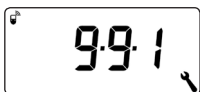

2. The number of logged-on DuoFern devices is displayed.



For example, one device is logged on here.

### 3. Logging on DuoFern devices:

- 3.1 Switch the respective DuoFern device to log-on mode.



- 3.2 Start the log-on process.

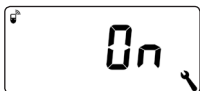

The display flashes [**On**].

- 3.3 The new number of logged-on devices appears after successfully logging on.



- 3.4 Log on the next DuoFern device

**or**

Back to the menu selection.



### 4. Logging off DuoFern devices:

---

4.1



Switch the respective DuoFern device to log-off mode.

---

4.2



Start the log-off process.

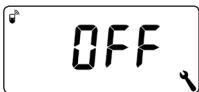

The display flashes [**OFF**].

---

4.3



The new number of logged-on devices appears after successfully logging off.

---

4.4 Log off the next DuoFern device

**or**

Back to the menu selection.



### Deleting all connections to the logged-on DuoFern devices

---

1.  4 sec. Press and hold the set button for 4 seconds.



The display flashes [**OFF**].

2.  All connections are subsequently deleted.

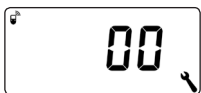

Deleting the connections can lead to problems for the participants, whereby the Troll Comfort DuoFern is still logged on even after the deletion process.

- ◆ Always use the "Log-off" function to terminate the connection with other DuoFern devices.





### Clearing up the DuoFern network

---

This function enables you to log off all DuoFern devices from the Troll Comfort DuoFern that are no longer accessible via radio.



All battery-operated DuoFern transmitters (e.g. the DuoFern Manual Central Operating Unit) cannot be logged off using this function.

1.  Open menu **9.9.1**.

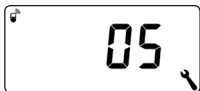

The number of logged-on DuoFern devices is displayed.

2.  4 sec. Activate the clear-up function.

In order to do this, press and hold the SET button for approx. 4 seconds.

3.  The display flashes.

The current number of logged-on DuoFern devices (e.g. 2) is displayed after a successful clear-up.



The Troll Comfort DuoFern features three DuoFern modes, enabling you to specify how the device behaves within the DuoFern network or in the local installation on-site.

### **Setting the following DuoFern modes in the Troll Comfort DuoFern**

#### **[ 1 ] = DuoFern receiver**

- ◆ The Troll Comfort DuoFern is controlled centrally (e.g. through scenes), for example, by the HomePilot®
- ◆ In addition, it can be remotely controlled by other DuoFern devices (e.g. a DuoFern Manual Transmitter)
- ◆ The automatic functions and switching times configured on the Troll Comfort DuoFern are not available in the DuoFern mode [ 1 ]

#### **[ 2 ] = DuoFern transmitter**

- ◆ The Troll Comfort DuoFern is integrated into a DuoFern network as a central controller and is intended to control other DuoFern devices with set automatic functions, switching times and manual commands
- ◆ When this mode is selected, the other settings in the menus **9.9.5** (Transmitting manual control commands) and **9.9.6** (Transferring automatic states) are available to you
- ◆ In addition, it can be remotely controlled by other DuoFern devices (e.g. a DuoFern Manual Transmitter)

#### **[ 3 ] = Local operation (factory setting)**

- ◆ The automatic functions and switching times configured on the Troll Comfort DuoFern are stored locally and can only be executed in order to control a connected tubular motor
- ◆ In addition, control commands can also be received and executed from the DuoFern network (e.g. from a DuoFern Manual Transmitter)



All manual and automatic control signals received via radio are executed on site regardless of the set mode.

### Exception

Control commands for the automated solar function are only accepted if the solar mode [3] is activated, see page 116.

1.  Open menu **9.9.2**.



2.  Set and confirm the desired DuoFern mode.



**1 = DuoFern receiver**

**2 = DuoFern transmitter**

**3 = Local operation**



If you use external sun sensors (e.g. the DuoFern Sun Sensor or the DuoFern Environmental Sensor in conjunction with the HomePilot®) or the Troll Comfort DuoFern itself as a central sun controller for other DuoFern devices, you can use this function to determine how the Troll Comfort DuoFern should react.

---

### The following solar modes can be selected:

---

[ 1 ] = **Local light sensor (factory setting)**

[ 2 ] = **Transmitter (local light sensor and transmitter function)**

[ 3 ] = **Receiver (external sun sensor)**

---

#### Mode [ 1 ] - Local light sensor \*

---

##### Select mode [ 1 ] if ...

- ◆ ...the Troll Comfort DuoFern is to be controlled by a light sensor connected to this device. Function and settings of mode [ 1 ] from page 69.

---

#### Mode [ 2 ] - Transmitter (local light sensor and transmitter function) \*

---

##### Select mode [ 2 ] if ...

- ◆ ...the Troll Comfort DuoFern and other logged-on DuoFern devices are to be controlled by a light sensor connected to the Troll device.

---

#### Mode [ 3 ] - Receiver (external sun sensor)

---

##### Select mode [ 3 ] if ...

- ◆ ...the Troll Comfort DuoFern is to be controlled by an external sun sensor or a central sun controller.

---

\* *No signals are executed from an external sun sensor or central sun controller in modes [ 1 ] and [ 2 ].*



1. Open menu **9.9.3**.



2. Set and confirm the solar mode.



**1 = Local light sensor, for more see page 69**

**2 = Transmitter (local light sensor and transmitter function \***

**3 = Receiver (external sun sensor; Requirement:**

The automatic solar function must be activated (**On**) and a sunshine position must be set in menu **4**.

### \* Solar mode [2]

If the solar mode [2] is selected, you have the option to set the sunshine position on the logged-on devices.

3. Select the device on which the sunshine position is to be set.

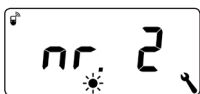

**2 to n = All logged-on devices in the order of logging on**

Battery-operated devices, such as a DuoFern Manual Transmitter, are not listed.



- 3.1  Check which device is currently selected by briefly tapping the button.  
**Tubular motors** run for a short time.  
**Switch actuators** briefly switch on/off.



- 3.2  Confirm the selected device.

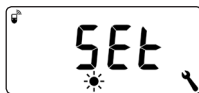
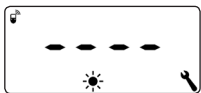

These two displays appear alternately on the display.



In order to ensure that the sunshine position is measured correctly, open the roller shutter completely before moving to the sunshine position.

-  3 min. Press the Up button. Leave the direction switched on for approx. 3 minutes.

4.  >  Move the roller shutter downwards and stop at the desired sunshine position.

5.  or  Press one of the two set buttons to confirm.



The corresponding DuoFern actuator will switch on briefly and **SEt** will flash on the display.

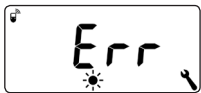

Error display if a selected device is not accessible via radio.

6.  Exit the sunshine position setting.



The Troll Comfort DuoFern can receive and display weather data (temperature, brightness, wind velocity, rain) from a DuoFern Environmental Sensor. It is not necessary to log the DuoFern Environmental Sensor onto the Troll Comfort DuoFern.

The weather data can be called up and displayed directly on the standard display, see page 47.

### **Maximum number of environmental sensors**

---

- ◆ A maximum of 4 environmental sensors are detected
- ◆ Only one sensor can ever be selected as the source

### **Observing delays in displaying the weather data**

---



Environmental sensors update the weather data approx. every 5 minutes and therefore it can take a few minutes for the new weather data to be displayed after the settings are configured.

- ◆ This also applies after a power failure.
- ◆ If no new weather data is received for 45 minutes, this is no longer available.



1. Open menu **9.9.4**.

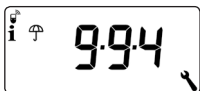

2. Switch the weather data display on/off and confirm.

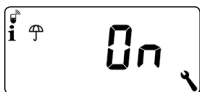





**On = on**  
**Off = off**

3. The last four digits of the DuoFern address (radio code) of the current environmental sensor are displayed.

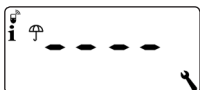

Display if no environmental sensor has been received or is in radio range so far.



4.  /  >  Select and confirm the desired environmental sensor.

### Deleting all detected environmental sensors



Briefly press the SET button.

All environmental sensors are deleted.





## 28.5 Menu 9.9.5 -Transmitting manual control commands

EN

**Additional function if the DuoFern mode [ 2 ] (DuoFern transmitter) is activated in menu 9.9.2, see page 114.**

The Troll Comfort DuoFern acts as a central controller to control other logged-on DuoFern devices in the DuoFern mode [ 2 ].

Activating this function enables you to use the operating buttons on the Troll Comfort DuoFern to transmit manual control commands to all logged-on DuoFern actuators. Individual actuators cannot be controlled via the Troll Comfort DuoFern.

If you deactivate the function (Off), you can only control the motor connected to the Troll Comfort DuoFern with the operating buttons.

1. Open menu **9.9.5**.

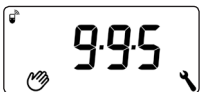

2. Switch the transmission of manual control commands on/off and confirm.

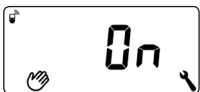

**On = transmission of manual control commands on \***

**Off = transmission of manual control commands off**



\* The operating buttons are used to transmit manual control commands to all logged-on DuoFern actuators on the standard display.



If the DuoFern mode [ 2 ] has not been activated in menu **9.9.2**, menu **9.9.5** remains completely hidden.



**Additional function if the DuoFern mode [ 2 ] (DuoFern transmitter) is activated in menu 9.9.2, see page 114.**

The Troll Comfort DuoFern acts as a central controller to control other logged-on DuoFern devices in the DuoFern mode [ 2 ].

Activating this function enables you to transfer the automatic states of the Troll Comfort DuoFern (automatic timer, automatic dawn and dusk function etc.) to logged-on DuoFern devices.

1. Open menu **9.9.6**.

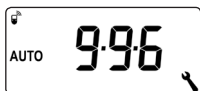

2. Switch the transfer of automatic states on/off and confirm.

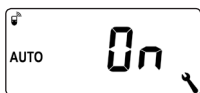

**On = transfer of automatic states on \***  
**Off = transfer of automatic states off**

\* The automatic states of the Troll Comfort DuoFern are transferred to all logged-on DuoFern devices.



If the DuoFern mode [ 2 ] has not been activated in menu **9.9.2**, menu **9.9.6** remains completely hidden.



## 28.7 Menu 9.9.7 - Displaying the DuoFern address (radio code)

EN

Each DuoFern device has an address (radio code) through which it communicates in the DuoFern network. If necessary, you can display the DuoFern address of the Troll Comfort DuoFern.

1.  Open menu **9.9.7**.

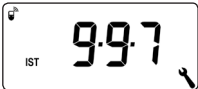

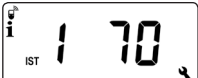
2.  Two digits of the six-digit DuoFern address are always shown consecutively in the form of scroll text, see example.

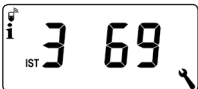
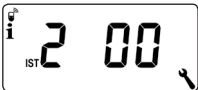

3. **M** or **OK** Back to the menu selection.

A software reset can be performed to reset the Troll Comfort DuoFern to the original default condition as when supplied.

1.  +  +  + 

Press and hold the four buttons simultaneously for 5 seconds until ... all the symbols are shown on the display.



- 2.

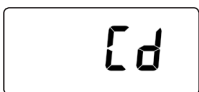

Then the device type (Cd = Comfort DuoFern) and software version are displayed for five seconds.

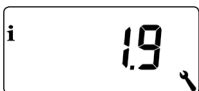

All settings are deleted and reset to the factory settings.

3. Start with the settings as specified from page 42 onwards (installation wizard).



The DuoFern connection data is retained after a software reset. You can log off or delete DuoFern devices in menu **9.9.1**, see page 110.

A hardware reset can be performed in the event that the Troll Comfort DuoFern no longer react to commands.

1. To do so, pull the operating unit out of the installation housing.

2. The centre section on the rear of the operating unit contains an opening with two contacts that must be carefully bridged for a few seconds, for example, with the help of a flat-head screwdriver.

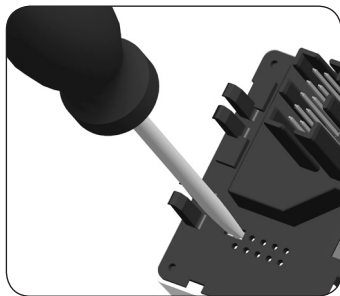

3. The operating unit can be returned to the installation housing as soon as the screwdriver has been removed from the contacts.

The time and date will be lost during a hardware reset. All other settings are retained.

**Error 1 (display "E1")**

---

The Troll Comfort DuoFern has an invalid DuoFern address (radio code).

- ◆ Please perform a hardware reset, see page 125.
- ◆ If the problem continues, check the DuoFern address (radio code) in menu **9.9.7**, see page 123.
  - Please then contact RADEMACHER Service, see page 132.

**Error 2 (display "E2")**

---

Internal device error highlighting that the Troll Comfort DuoFern may be defective.

- ◆ Please then contact RADEMACHER Service, see page 132.

**Error 3 (display "E3")**

---

There is a communication problem.

- ◆ Check that all logged-on actuators and the HomePilot® if necessary are connected properly and within range.
- ◆ A repeater may be required for larger distances.

Each DuoFern device that is connected to the mains power supply is a repeater (e.g. switch actuator sockets, HomePilot®, DuoFern actuators etc).
- ◆ If devices have been logged on that are no longer available (e.g. due to a defect, amongst other things), these can be deleted by the "Clear-up" function, see page 113.

**DANGER!**

**There is a risk of fatal electric shock when touching electrical components.**

- ◆ Disconnect all phases of the mains power cable and secure it to prevent any reconnection. Check that the system is de-energised.

1. Log the Troll Comfort DuoFern off the DuoFern network.
2. Switch off the mains power, secure it against restarting and check that the system is de-energised.
3. Carefully pull the operating unit out of the installation housing.
4. Remove the frame.
5. Release the claw fasteners of the installation housing and pull it out of the flush-mounted box.
6. Disconnect the connecting cable from the installation housing.
7. Secure the connection point against restarting and the connecting cable from unintentional contact.

**Belgium**

- 101 Antwerp
- 102 Bruges
- 103 Brussels
- 104 Liège
- 105 Mechelen
- 106 Mons
- 107 Ostend

**Denmark**

- 108 Aalborg
- 109 Ringsted
- 110 Esbjerg
- 111 Horsens
- 112 Kolding
- 113 Copenhagen
- 114 Svendborg
- 115 Randers

**Great Britain**

- 116 Aberdeen
- 117 Birmingham
- 118 Bristol
- 119 Glasgow
- 120 London
- 121 Manchester
- 122 Newcastle

**Estonia**

- 123 Tallinn

**Finland**

- 124 Helsinki
- 125 Jyväskylä
- 126 Oulu
- 127 Tampere
- 128 Turku
- 129 Vasa

**France**

- 130 Bordeaux
- 131 Brest
- 132 Dijon
- 133 Le Havre
- 134 Lyon
- 135 Montpellier
- 136 Nantes
- 137 Nice
- 138 Paris
- 139 Reims
- 140 Strasbourg
- 141 Toulon

**Italy**

- 142 Bologna
- 143 Bolzano
- 144 Florence
- 145 Genoa
- 146 Milan
- 147 Naples
- 148 Palermo
- 149 Rome
- 150 Turin
- 151 Venice

**Ireland**

- 152 Cork
- 153 Dublin
- 154 Belfast

**Latvia**

- 155 Riga

**Liechtenstein**

- 156 Vaduz

**Lithuania**

- 157 Vilnius

**Luxembourg**

- 158 Luxembourg

**The Netherlands**

- 159 Amsterdam
- 160 Eindhoven
- 161 Enschede
- 162 Groningen
- 163 Maastricht
- 164 Rotterdam
- 165 Utrecht

**Norway**

- 166 Oslo
- 167 Stavanger
- 168 Bergen
- 169 Trondheim

**Austria**

- 170 Amstetten
- 171 Baden
- 172 Braunau
- 173 Brixen
- 174 Bruck/Mur
- 175 Eisenstadt
- 176 Graz
- 177 Innsbruck
- 178 Klagenfurt
- 179 Landeck
- 180 Linz
- 181 Nenzing
- 182 Salzburg
- 183 Vienna

**Poland**

- 184 Breslau
- 185 Bromberg
- 186 Gdańsk



187	Kattowitz	218	Badajoz	252	Sofia
188	Kraków	219	Burgos	253	Skopje
189	Lodz	220	Cáceres	254	Thessaloniki
190	Lublin	221	Castellón	255	Zagreb
191	Posen	222	Granada		
192	Szczecin	223	Guadalajara		
193	Warsaw	224	La Coruña		
	<b>Portugal</b>	225	Lérida		
194	Faro	226	León		
195	Lisbon	227	Madrid		
196	Porto	228	Murcia		
	<b>Switzerland</b>	229	Oviedo		
197	Basel	230	Palma		
198	Bern	231	Pamplona		
199	Andermatt	232	San Sebastián		
200	Chur	233	Seville		
201	Lausanne	234	Santander		
202	Lucerne	235	Valencia		
203	Zurich	236	Valladolid		
	<b>Sweden</b>	237	Vitoria		
204	Boras	238	Zaragoza		
205	Gävle	239	La Palma		
206	Göteborg	240	Tenerife		
207	Helsingborg	241	Gran Canaria		
208	Jönköping	242	Fuerteventura		
209	Östersund		<b>South-east Europe</b>		
210	Malmö	243	Athens		
211	Stockholm	244	Belgrade		
212	Sundsvall	245	Bratislava		
213	Umeå	246	Bucharest		
	<b>Spain</b>	247	Budapest		
214	Almería	248	Istanbul		
215	Alicante	249	Maribor		
216	Barcelona	250	Prague		
217	Bilbao	251	Sarajevo		



RADEMACHER Geräte-Elektronik GmbH, hereby declares that the Troll Comfort DuoFern complies with the Directive **2014/53/EU (Radio Equipment Directive)**.

The full text of the declaration of conformity is available at the following website:

[www.rademacher.de/ce](http://www.rademacher.de/ce)

### Light sensor

Item no.	Cable length
7000 00 88	0.75 m
7000 00 89	1.5 m
7000 00 90	3 m
7000 00 91	5 m
7000 00 92	10 m



RADEMACHER Geräte-Elektronik GmbH will provide a 24-month warranty for new systems that have been installed in compliance with the installation instructions. All construction faults, material defects and manufacturing defects shall be covered by the warranty.

Your statutory warranty claims remain unaffected by this warranty.

**The following are not covered by the warranty:**

- ◆ Incorrect fitting or installation
- ◆ Non-observance of the installation and operating manual
- ◆ Improper operation or wear and tear
- ◆ External influences, such as impacts, knocks or weathering
- ◆ Repairs and modifications by third parties, unauthorised persons
- ◆ Use of unsuitable accessories
- ◆ Damage caused by unacceptable excess voltages (e.g. lightning)
- ◆ Operational malfunctions caused by radio frequency overlapping and other such radio interference

A prerequisite for the warranty is that the new device must have been purchased from one of our approved specialist retailers. Proof of this must be provided by presenting a copy of the invoice.

RADEMACHER will remedy any defects that occur within the warranty period free of charge either by repair or by replacement of the affected parts or by supplying a new replacement unit or one to the same value. There is no general extension of the original warranty period by delivery of a replacement or by repair as per the terms of the warranty.

## **RADEMACHER**

Geräte-Elektronik GmbH  
Buschkamp 7  
46414 Rhede (Germany)  
info@rademacher.de  
www.rademacher.de

### **Service:**

Hotline 01807 933-171\*  
Telefax +49 2872 933-253  
service@rademacher.de

- \* 30 seconds free of charge, subsequently 14 cents / minute from German fixed line networks and max. 42 cents / minute from German mobile networks.