



Item No.:

1423 45 11

1423 60 11 (Standard DuoFern Plus)

1415 45 11 (Small belt)



Dear Customer,

EN

With your purchase of a **RolloTron Standard DuoFern**, you have chosen a quality product manufactured by RADEMACHER. Thank you for the trust you have placed in us.

This roller shutter belt winder has been designed both in order to provide optimal convenience and operability as well as to ensure solidity and durability. Having applied uncompromising quality standards, and carried out thorough testing, we are proud to be able to present you with this innovative product.

It's brought to you by all the highly-qualified personnel here at RADEMACHER.



These instructions...

...describe how to install the equipment, connect the electrical system and operate your roller shutter belt winder.



Before you begin, please read these instructions through completely and follow all the safety instructions.

This manual is a component of the product. Please store it in an easily accessible place. When passing the RolloTron Standard DuoFern on to a third party, this manual must be passed on as well.

Damage resulting from non-compliance with these instructions and safety instructions will void the guarantee. We assume no liability for any consequential damage.

i	Dear Customer,.....	2	14.	Automatic mode; brief description	29
1.	Hazard symbols.....	4	14.1	Switch all automatic functions on / off simultaneously	29
1.1	Levels of danger and signal words.....	4	15.	Setting the position of the sun.....	30
1.2	Symbols and depictions used.....	4	15.1	Switching the automated solar function on/off	30
2.	Safety instructions.....	5	16.	Switching the automatic timer on/off	31
2.1	Proper use	6	17.	Switching the automatic twilight function on/off.....	32
2.2	Improper use.....	7	18.	Switching the automatic dawn function on/off.	32
2.3	Required expert knowledge of the installer.....	7	19.	Set the ventilation position	33
3.	Scope of delivery (item no. 1423 45 11) *	8	20.	Setting the motor speed for automatic functions.....	34
4.	General view (item no. 1423 45 11) *	9	21.	Erase all settings, software reset.....	35
5.	Permissible roller shutter belts	10	22.	Carry out hardware reset.....	35
6.	Functional description.....	11	23.	Removing the RolloTron Standard DuoFern (e.g. in the event of a move)	36
6.1	Description of safety functions	12	24.	Removing the belt in the event of unit failure ...	38
6.2	Table 3: DuoFern network function table.....	13	25.	What to do if... ?	39
7.	General assembly instructions.....	14	26.	Information about maintenance and care of your equipment	42
7.1	You will need the following tools	14	27.	Technical Specifications.....	43
7.2	P reparation for installation.....	15	28.	Tractive force diagrams	44
8.	Safety instructions for electrical connection	17	29.	Simplified EU Declaration of Conformity	45
8.1	Electrical connection.....	18	30.	Accessories.....	45
9.	Drawing in and fastening the belt.....	19	31.	Warranty conditions.....	46
10.	Mounting the RolloTron Standard DuoFern	21			
11.	End point adjustment	22			
12.	Manual operation	24			
13.	Logging DuoFern transmitters on/off; brief description.....	25			
13.1	Login for DuoFern transmitters.....	26			
13.2	Logging off DuoFern transmitters.....	27			
13.3	Clearing the DuoFern network.....	28			

i 1. Hazard symbols



Danger of fatal electric shock



Danger area / dangerous situation

i 1.1 Levels of danger and signal words

! DANGER!

This hazard will result in serious injury or death if not avoided.

! WARNING!

This hazard may result in serious injury or death if not avoided.

! CAUTION!

This hazard may result in minor or moderate injury if not avoided.

! ATTENTION!

This hazard may lead to property damage.

i 1.2 Symbols and depictions used

- 1. Steps to be taken
- 2.

◆ Itemisation

- 1. List



Please read the respective manual



further useful information



The use of defective equipment can lead to personal injury and damage to property (electric shocks, short circuiting).

- ◆ Never use defective or damaged equipment.
- ◆ Check the device and mains cable beforehand for damage.
- ◆ Should you discover damage to the equipment, please consult our customer service department (see page 48).



Incorrect use leads to an increased risk of injury.

- ◆ Train all personnel to use the RolloTron Standard DuoFern safely.
- ◆ This device may be used by children from 8 years of age upwards as well as by persons with reduced physical, sensory or mental capacities or with lack of experience and knowledge if they are supervised or have been instructed on how to use the device safely and if they understand what dangers may result from this.
- ◆ Children must not play with the device.
- ◆ Cleaning and user maintenance may not be carried out by children without supervision.
- ◆ Watch the moving roller shutters whilst carrying out the settings and during normal operation, and keep other people away from the area to avoid injury in the event the shutters suddenly slip.

- ◆ Carry out all cleaning work on the roller shutters whilst the device is disconnected from the mains power.

The mains socket and plug must be easily accessible at all times.



Exceeding the maximum permissible running time (KB) can overload and damage the RolloTron Standard DuoFern.

- ◆ The maximum permissible running time for a cycle may not be exceeded when the equipment is in operation. For this reason, the RolloTron Standard DuoFern has an automatic **running time limit (KB)** of four minutes.
- ◆ If the running time limit is triggered, then the RolloTron Standard DuoFern must be left for at least 12 minutes to cool down. Full operational availability is re-established after approx. one hour.



2. Safety instructions

According to DIN EN 13659, it is necessary to determine that the movement conditions for the shutters are maintained in accordance with EN 12045.



- ◆ The displacement must amount to at least 40 mm on the lower edge in the rolled-out position with a force of 150 N in the upwards direction.
- ◆ In doing so, it must be ensured that the extending speed of the shutters for the final 0.4 m is less than 0.15 m/s.



2.1 Proper use

Only use the RolloTron Standard DuoFern for opening and closing roller shutters with a permissible belt.



Mechanical locks of any kind are not suitable for automated operation with this device.

Only use original spare parts from RADEMACHER.

- ◆ By doing so, you avoid the risk of malfunctions and damage to your RolloTron Standard DuoFern.
- ◆ As the manufacturer, we provide no guarantee for the use of third-party components and accept no liability for consequential damage resulting from such.
- ◆ All repairs to the RolloTron Standard DuoFern must be undertaken by authorised customer service personnel.

Operating conditions

- ◆ Only operate the RolloTron Standard DuoFern in dry rooms.
- ◆ A 230 V / 50 Hz power supply, together with a site-provided isolating device (fuse, MCB), must be permanently available at the installation location.
- ◆ An easily accessible 230 V / 50 Hz socket must be available at the installation site if the enclosed connecting cable with Euro plug is being used.
- ◆ The roller shutters must run up and down smoothly and should not stick.
- ◆ The mounting surface for the RolloTron Standard DuoFern must be flat.

2.1 Proper use

- ◆ The installation and operation of the RolloTron Standard DuoFern is only permitted for those systems and devices where a malfunction in the transmitter or receiver would not cause a danger to personnel or property or where this risk is already covered by other safety equipment.



Radio systems which transmit on the same frequency can cause interference.

2.2 Improper use

Using the RolloTron Standard DuoFern for purposes other than previously mentioned is impermissible and is regarded as improper use.



There is a risk to life caused through short circuiting and electric shocks if the RolloTron Standard DuoFern is used outside.

- ◆ Never install or operate the RolloTron Standard DuoFern outside.



Improper use can lead to serious injuries or property damage.

- ◆ Never use the DuoFern radio system and its components (e.g. RolloTron Standard DuoFern) for remote control of devices and systems with heightened safety-relevant requirements or where there is a heightened risk of accidents. This shall require additional safety equipment. Observe the respective statutory regulations for the installation of such systems.

2.3 Required expert knowledge of the installer

The electrical connection, installation and commissioning of the RolloTron Standard DuoFern must only be carried out by a qualified electrician in accordance with the instructions in this manual.



3. Scope of delivery (item no. 1423 45 11) *

EN

* also applies to item numbers 1423 60 11 / 1415 45 11

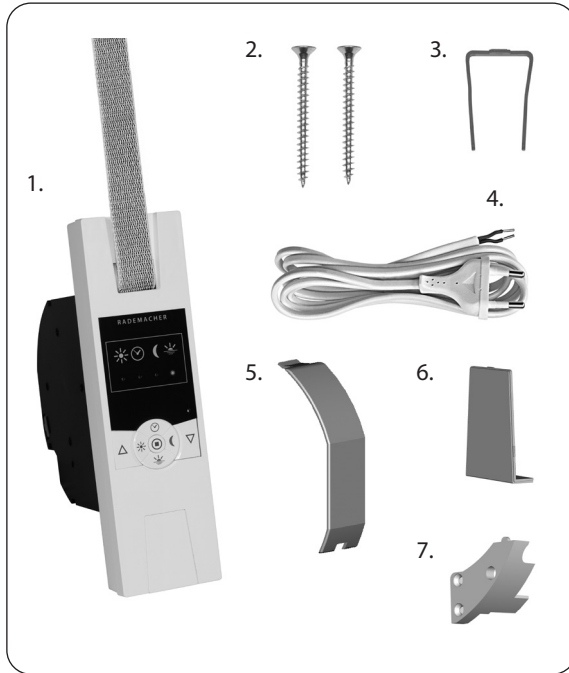

Legend

1. Belt Winder RolloTron Standard DuoFern or Standard DuoFern Plus
2. 2 x assembly screws (4 x 55 mm)
3. Disengaging bracket (in housing)
4. Connection cable with Euro-plug
5. Reel compartment cover
6. Cover plate
7. Traction relief mechanism including assembly screws

After unpacking please check and compare ...

the contents of the package with the above specified.

Check the details on the type plate

Check that the voltage / frequency on the type plate corresponds to the local mains conditions.



4. General view (item no. 1423 45 11) *

EN

* also applies to item numbers 1423 60 11 / 1415 45 11

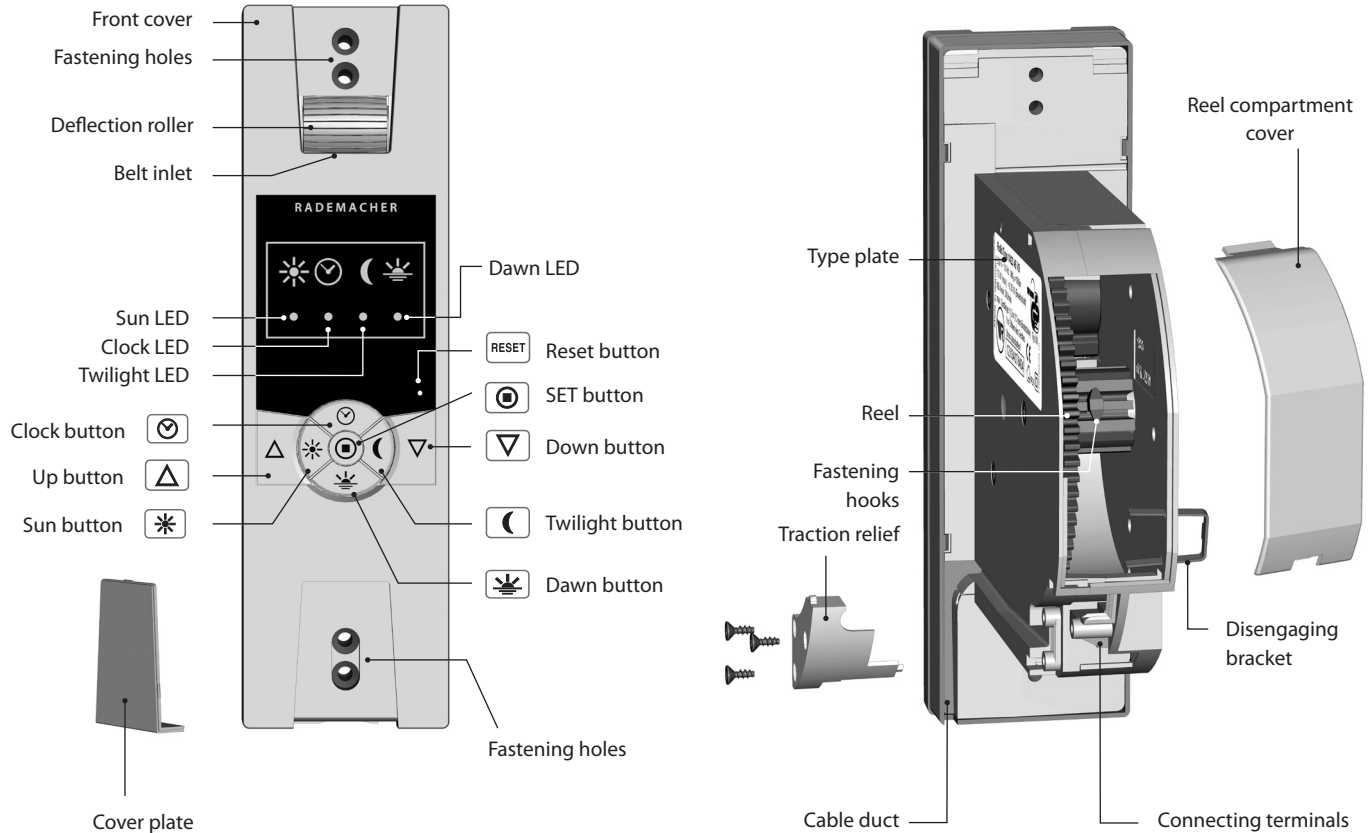



5. Permissible roller shutter belts

EN

ATTENTION!

The RolloTron Standard DuoFern may be damaged if excessively long belts are used.

Only use belts of the permissible lengths.



The specifications are intended for guidance only and apply to an ideal installation situation. The actual values may vary due to local conditions.

Table 1: Permissible roller shutter belts

RolloTron:		Standard DuoFern (Small belt)	Standard DuoFern	Standard DuoFern Plus
Item No:		1415 45 11	1423 45 11	1423 60 11
Belt width:	Belt thickness:	Maximum belt length		
15 mm (Small belt)	1.0 mm	7.6 m	---	---
	1.0 mm	---	7.6 m	15 m
23 mm (Standard belt)	1.3 mm	---	6.2 m	12 m
	1.5 mm	---	5.2 m	11 m

Table 2: Permissible roller shutter surface area (m²)

Roller shutter type:	Weight/m²	Permissible roller shutter surface area (m²)		
Plastic roller shutters	(4.5 kg/m ²)	Approx. 6 m ²	Approx. 6 m ²	Approx. 10 m ²
Aluminium and wooden roller shutters	(10.0 kg/m ²)	Approx. 3 m ²	Approx. 3 m ²	Approx. 6 m ²

The RolloTron Standard DuoFern is a roller shutter drive designed for use inside. It is fitted as a flush-mounted device and the power supply is provided via the enclosed connecting cable with plug or a fixed installed lead.

The RolloTron Standard can be controlled individually on site or it can be integrated into a DuoFern network.

As soon as you integrate your RolloTron Standard DuoFern into a DuoFern network, you can make use of many functions offered by the corresponding DuoFern controllers.

The DuoFern actuators and transmitters must be connected to the DuoFern network.

The automatic functions including switching times, dawn and dusk control, solar functions, etc. are only available if the RolloTron Standard DuoFern is operated with a respective controller (e.g. DuoFern central operating unit, HomePilot®, etc.) (see page 25).

You can find a detailed description of the various functions, configuration options and possible combinations for the DuoFern system at:

<http://www.rademacher.de/duofern>.

Central control of several RolloTron Standard DuoFern devices with a single RolloTron Comfort DuoFern.

A **DuoFern network** generally includes the **DuoFern central operating unit** or the **HomePilot®** (together with the associated user interface) as the central controllers.

Alternatively, you can control one or more RolloTron Standard DuoFern devices with a single **RolloTron Comfort DuoFern**. In doing so, the automatic functions configured for the RolloTron Comfort DuoFern are also executed by the logged-on RolloTron Standard DuoFern.

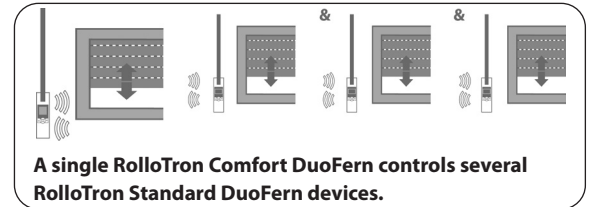

Automatic LED dimming

The RolloTron Standard DuoFern is equipped with automatic dimming LEDs to reduce the light intensity (e.g. bedrooms). The LEDs dim as the roller shutters are lowered.

Soft-start / Soft-stop

The RolloTron Standard DuoFern is equipped with a Soft-start / Soft-stop function. Gentle starting and stopping serves to protect the belt winder mechanics and the belt.

Obstacle detection

The movement of the belt is monitored. If the roller shutters hit an obstacle in the DOWN (▽) direction, the belt will stop moving and the belt winder is switched off.



Once the system has switched off, it is no longer possible to directly operate the drive in the same direction.

- ◆ Run the belt winder back in the opposite direction and remove any possible obstacle.
- ◆ Subsequently it is possible to operate the drive in the original direction again.



There is a risk of injury if the obstacle detection is not working.

- ◆ The belt must be wound on as evenly as possible to ensure safe and correct functioning of the obstacle detection function.
- ◆ Please ensure that the belt winds as straight and evenly as possible into the device during its subsequent cycle after the obstacle detection system has triggered.

Overload cut-off

The RolloTron Standard DuoFern is equipped with an overload cut-off system.

If the drive jams in the UP (△) cycle (for example, due to ice), the belt winder will also switch off.

- ◆ Once the cause for the overload has been rectified, the drive is fully operational in both directions.

			HomePilot®						
			DuoFern environmental sensor				DuoFern central operating unit		
			* WR ConfigTool with DuoFern central operating unit						
			RolloTron Comfort DuoFern / Troll Comfort DuoFern						
			DuoFern standard manual transmitter						
			DuoFern wall controller						
Function	Value range	Factory setting							
1. Manual operation	Up / Stop / Down	-	●	●				●	●
2. Direct drive to a %-position	0 - 100 %	-							●
3. Manual mode on / off	on / off	Off					●	●	●
4. Timer on / off	on / off	On					●	●	●
5. Random function	-	-			●			●	●
6. Automatic dawn function	-	-			●			●	●
7. Automatic dawn function on / off	on / off	Off					●	●	●
8. Automatic dusk function	-	-			●			●	●
9. Automatic dusk function on / off	on / off	Off					●	●	●
10. Sun function	-	-			●				●
11. Automatic solar function on / off	on / off	Off					●	●	●
12. Sun position	0 - 100 %	50 %					●	●	●
13. Ventilation position on / off	on / off	Off					●	●	●
14. Ventilating position	1 - 99 %	80 %					●	●	●
15. Connectivity test	-	-							●

* The "WR ConfigTool" software can be downloaded from our website at www.rademacher.de

i 7. General assembly instructions



Poor routing of the belt can cause the belt to fail and leads to unnecessary loads on the RolloTron Standard DuoFern.

- ◆ Install the belt winder so that the belt runs as straight as possible into the device, in order to avoid unnecessary friction and wear.



Incorrect installation can lead to property damage.

- ◆ Strong forces are exerted during operation of the system which require secure installation on a firm base.



In order to ensure optimal operation, the RolloTron Standard DuoFern should not be installed near metal objects.

i 7.1 You will need the following tools

- ◆ Screwdriver
- ◆ Scissors
- ◆ Carpenter's gauge or measuring tape
- ◆ Pen

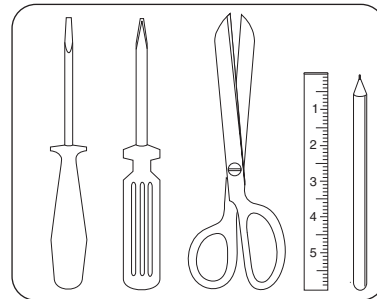



7.2 Preparation for installation

EN

1. Take measurements.
Check that the belt box has sufficient space to house the RolloTron Standard DuoFern.

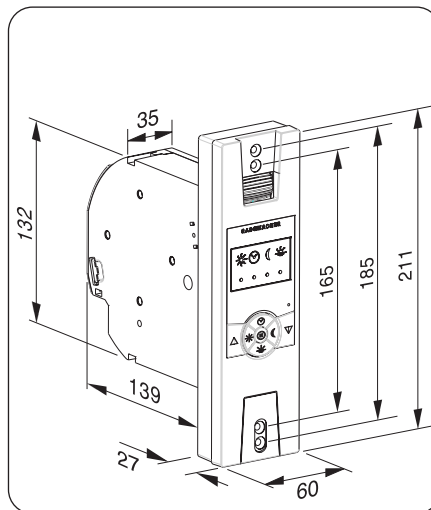

All dimensions in mm

RolloTron Standard DuoFern

Item no.:

1415 45 11 (Small belt)

1423 45 11 (Standard belt)

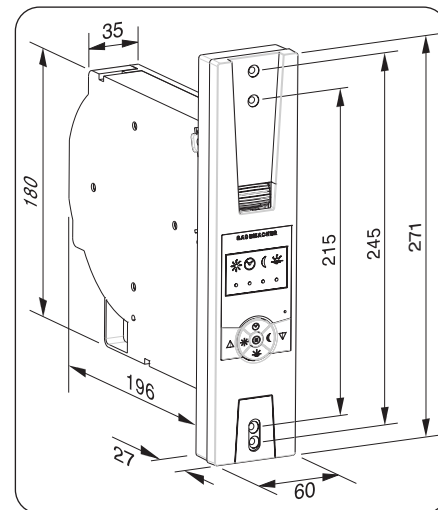

All dimensions in mm

RolloTron Standard DuoFern Plus

Item no.:

1423 60 11 (Standard belt)



7.2 Preparation for installation

EN

2. Remove the old belt winder, if you are carrying out a conversion to an existing roller shutter system.
- 2.1 Let the roller shutter move fully down, until the slats are completely closed.
- 2.2 Remove the old belt winder and unreel the belt.

CAUTION!

There is a risk of injury from the pre-tensioned springs on the old belt winder.

- ◆ The spring unit can suddenly recoil when it is removed.
- ◆ Hold the spring unit firmly when loosening the belt and allow it to recoil slowly until the spring unit has completely unwound.

3. Prepare the belt.
- 3.1 Cut the belt off approx. 20 cm under the belt box.
- 3.2 Fold the end of the belt over by approx. 2 cm and cut a short slit in the centre. This enables you to subsequently hook the belt onto the reel.

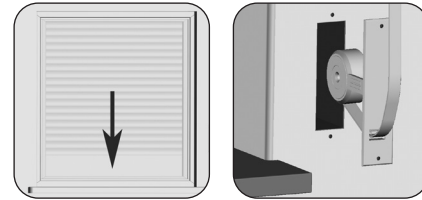

Recommendation

The belt must run as straight and freely as possible. For stiff roller shutters, mount a deflection roller on the belt box. This helps to prevent unnecessary friction and wear to the belt.

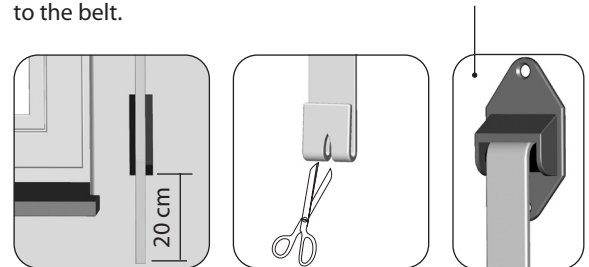

Accessories, see page 45.



8. Safety instructions for electrical connection

DANGER!



Danger due to electric shock when working on all electrical systems.

- ◆ Carry out all installation and connection work only in an isolated, zero-volts state.
- ◆ Disconnect all phases of the mains power supply cable and secure it to prevent any reconnection.
- ◆ Check the system for a zero-voltage status.



The electrical connection for the RolloTron Standard DuoFern can be made either with the supplied connecting cable or via a fixed laid cable.



8.1 Electrical connection

EN

1. Connect the provided connecting cable to the connecting terminals of the RolloTron Standard DuoFern.
The colour coding is irrelevant for the installation.

WARNING!



Damaged cables can cause short circuits.

- ◆ Pay attention that cables are laid safely.
- ◆ The connecting cable may not be pinched when screwing on the belt winder as this could lead to damage.

2. Lay the connecting cable to the RolloTron Standard DuoFern in a cable duct.
3. Finally, screw on the traction relief mechanism with the screws provided.

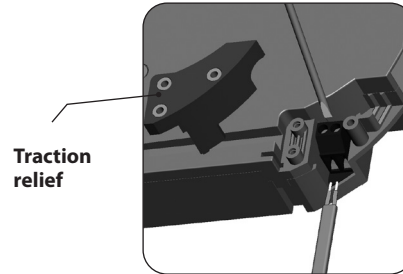

**RolloTron
Standard DuoFern**

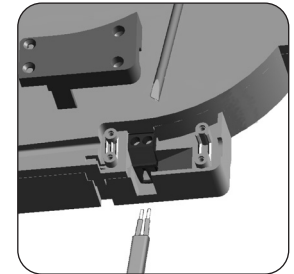

**RolloTron
Standard DuoFern Plus**

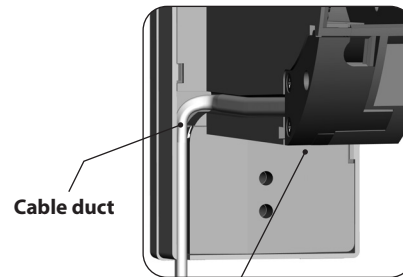

Traction relief

i 9. Drawing in and fastening the belt

1. Insert the mains plug into the socket.

⚠ CAUTION!

There is a risk of injury from the reel.

Never reach into the reel compartment when the motor is running.

2. **⚠** Press the UP button until the fastening hooks are easily accessible in the reel compartment.



As no end points have been set yet, the drive will stop as soon as you release the button.

3. Always remove the mains plug from the socket.

4. Next, draw-in the belt into the RolloTron Standard DuoFern from the top.

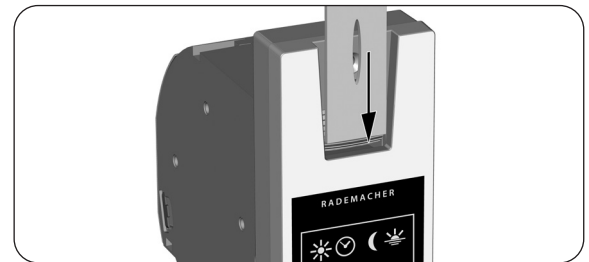
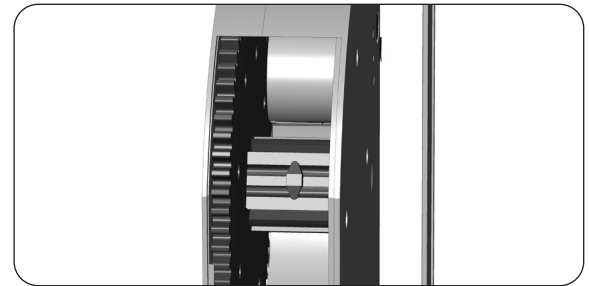



9. Drawing in and fastening the belt

EN

5. Continue to feed the belt into the device as shown in the bottom right sectional diagram and subsequently slide the belt over the fastening hooks from above.
6. Re-insert the mains plug into the socket.
7.  Press the UP button until the belt has wound around the reel once completely.
8. Pull the belt tight when winding, so that the deflection roller turns at the same time.
9. Finally remove the mains plug from the socket again.
10. Finally, place the provided reel compartment cover onto the reel compartment.

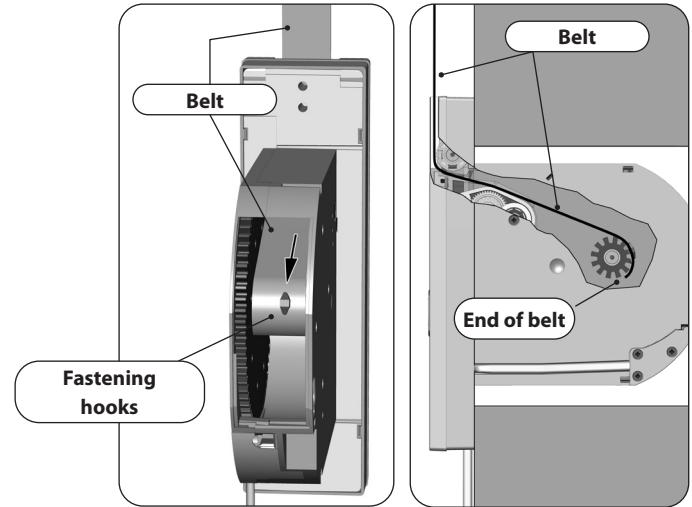

**Belt path in
RolloTron Standard DuoFern**

Mount the RolloTron Standard DuoFern as straight as possible, so that the belt can wind correctly.

Ensure that the RolloTron Standard DuoFern sits freely in the belt box and that it is not in contact with the masonry, otherwise noise will be generated during operation.

1. Slide the RolloTron Standard DuoFern into the belt box and screw it tight using the screws provided.

⚠ WARNING!



A damaged connecting cable may cause a short circuit.

Ensure that the connecting cable is laid correctly inside the cable duct, otherwise it can be crushed and damaged when the cover is screwed in place.

2. Slide the enclosed cover plate over the lower mounting holes.
3. Re-insert the mains plug into the 230 V / 50 Hz socket.

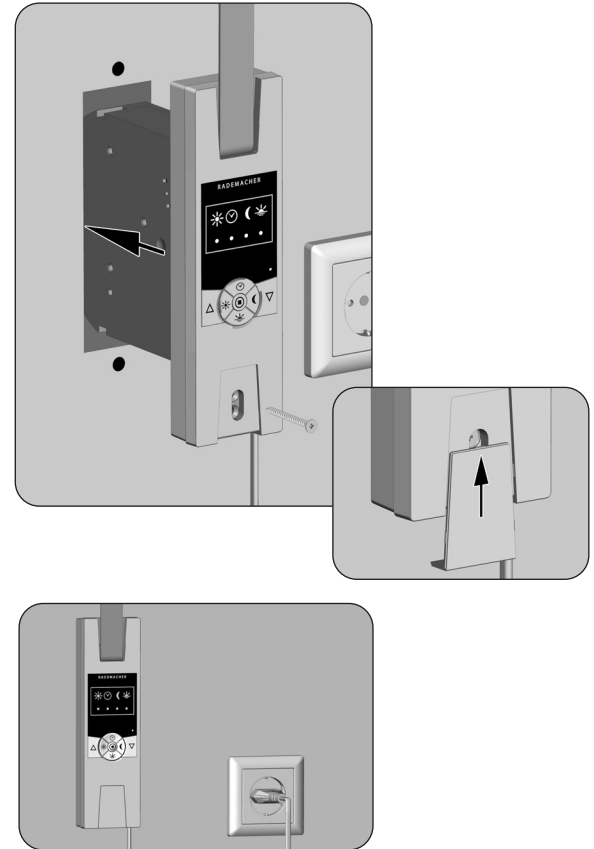



11. End point adjustment

Additional information about configuring the end points



The end points must be configured in order that the roller shutters stop at the desired upper and lower positions. It is imperative that both end points are configured, otherwise malfunctions may occur.





If the RolloTron Standard DuoFern is operated without an end point setting, the drive will continue to run for as long as one of the two control buttons is actuated.

The automatic functions remain blocked until the end point setting is configured.

Set the upper end point

1.  +  Simultaneously press and hold the buttons.
The roller shutters travel up.

- 1.1 Tighten the belt slightly, until it is tensioned by the weight of the roller shutters.

2.  +  Release the buttons as soon as the roller shutter achieves the desired position for the upper end point.
The roller shutter stops and the upper end point is stored.



ATTENTION!





Setting the wrong upper end point may lead to overload or damage the RolloTron Standard DuoFern or the drive.

- ◆ Do not set the upper end point right up to the limit stop.
- ◆ Release the button promptly and never allow it to extend beyond the respective end point.



11. End point adjustment

Set the lower end point

3.  +  Simultaneously press and hold the buttons.
The roller shutters travel down.
4.  +  Release the buttons...
...as soon as the roller shutter achieves the desired position for the lower end point. The roller shutter stops and the lower end point is stored.



Please ensure that the belt is not excessively slack when reaching the lower end point.

Changing or correcting the end points

5. Move the roller shutters to the centre position and configure the respective end point again.







After a period of time it may be necessary to reconfigure the end points as the belt may elongate during the process of operation.



12. Manual operation

Manual operation is always possible and has priority over the programmed automatic functions.

1.  Open the roller shutters.
Briefly pressing the button causes the roller shutters to move to the upper end point.
2.  or  Causes the roller shutters to stop in the interim.
3.  Closing the roller shutters.
Briefly pressing the button causes the roller shutters to move to the lower end point.

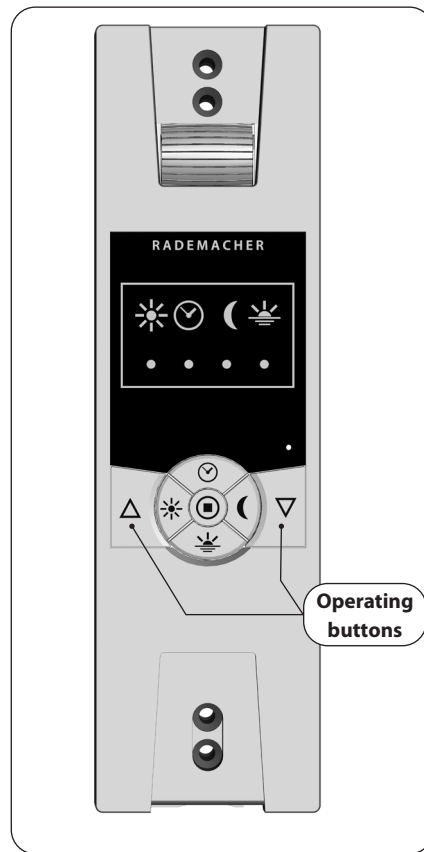



13. Logging DuoFern transmitters on/off; brief description

In order for your RolloTron Standard DuoFern to react to control signals from the DuoFern network, it is necessary to log **each DuoFern transmitter** (e.g. RolloTron Comfort DuoFern, DuoFern central operating unit, etc.) on to the RolloTron Standard DuoFern.



To do so, please read the operating instructions for the respective DuoFern transmitter.

Maximum number of connected devices

You can assign a **maximum of 20 DuoFern transmitters** to a single RolloTron Standard DuoFern.



A RolloTron Standard DuoFern cannot be connected to another RolloTron Standard DuoFern device.



Additional information about logging on can be obtained from the **login matrix** on our website under:

www.rademacher.de



13.1 Login for DuoFern transmitters

EN

1.  +  Activate login mode.
Simultaneously press and hold the buttons for approx. 4 seconds.



The timer LED flashes **green**:



Login mode remains active for approx. **120 seconds**.

2. Switch the desired DuoFern transmitter to login mode.

3.  Pay attention to the timer LED.



Flashes green

Login mode is active.



green (for 5 seconds)

Login was successful.



red

The login process failed, for example if:

- ◆ 20 DuoFern transmitters have already been registered.
- ◆ An attempt was made to register an unsuitable device (e.g. other DuoFern actuator).

4. Register the next DuoFern transmitter by repeating steps 1 to 2, or quit login mode.



5. 

Cancel registration.

You can cancel the login process at any time by briefly pressing the **[SET]** button.



13.2 Logging off DuoFern transmitters

1.  +  Activate logout mode.
Simultaneously press and hold the buttons for approx. 4 seconds.



The timer LED flashes **red**:



Logout mode remains active for approx. **120 seconds**.

2. Switch the desired DuoFern transmitter to logout mode.

3.  Pay attention to the timer LED.



flashes red

Logout mode is active.



green (for 5 seconds)

Logout was successful.



red

The logout process failed, for example if:

- ◆ An attempt was made to log-off a DuoFern transmitter that is not logged-on.

4. Logout the next DuoFern transmitter by repeating steps 1 to 2, or quit logout mode.

5. 

Cancel the logout process.

You can cancel the logout process at any time by briefly pressing the **[SET]** button.



13.3 Clearing the DuoFern network

This function enables you to clear all DuoFern transmitters from the RolloTron Standard DuoFern which are no longer accessible via radio.



Not all battery-operated DuoFern transmitters (e.g. the DuoFern central operating unit) can be logged off in this way.

A software reset must be carried out in order to logout and delete all DuoFern transmitters (see page 35).

1.  +  + 

Activate the clear function.
Simultaneously press and hold the buttons for approx. 4 seconds.

The timer LED flashes **red**:



2. 

The timer LED will light up green as soon as the clearing process has completed.



You can cancel the clearing process at any time by briefly pressing the **[SET]** button.



14. Automatic mode; brief description

The RolloTron Standard DuoFern features four automatic functions:

- ◆ Automated solar function
- ◆ Automatic timer
- ◆ Automatic dusk function
- ◆ Automatic dawn function

The automatic functions are only available if the RolloTron Standard DuoFern is operated with a respective controller (e.g. DuoFern central operating unit, HomePilot®, etc.) (see page 25).

All of the automatic functions can be combined as well as independently activated and deactivated on the RolloTron Standard DuoFern.

The status of each automatic function is indicated by the respective LED.





14.1 Switch all automatic functions on / off simultaneously

1.  Press and hold [SET] for approx. 1 second.
2. All automatic functions will be simultaneously switched on or off.
3. Observe the LEDs indicating the status of the automatic functions.
4. Once automatic mode is deactivated, it is only possible to operate the system manually.



15. Setting the position of the sun

You can set an arbitrary position (**position of the sun**) which your roller shutters will lower to when the automated solar function is activated.

1.  /  Move the roller shutters to the desired position and stop.

2.  + 



Save the position of the sun.

The solar LED flashes by way of confirmation. Once the button is released, the automated solar function is activated and the LED lights up permanently.



15.1 Switching the automated solar function on/off

The automated solar function enables brightness-dependent control of your roller shutters. The control signals for this function are provided by a light sensor on the DuoFern network.

When the automated solar function is triggered, your roller shutters will then lower to the configured **position of the sun**.

1. 

Press and hold the solar button for approx. 1 second.

2. 



Observe the solar LED:

OFF

The automatic solar function is switched off.

ON

The automatic solar function is switched on.

Flashing

The automated solar function is active, the roller shutters will be lowered to the **position of the sun**. The LED continues to flash when the roller shutters are in the position of the sun.



16. Switching the automatic timer on/off

Execution of control signals from the DuoFern network

If the automatic timer is activated, control signals for opening and closing times will be received from the DuoFern network and executed by the system.

Executing a random function

If the RolloTron Standard DuoFern receives a control signal from a DuoFern transmitter with activated random function (e.g. from a RolloTron Pro Comfort DuoFern), then it is also able to execute the random function. The random function generates a random delay between 0 and 30 minutes to the switching time.

The random function cannot be switched on/off on site.

1.

Press the timer button for approx. 1 second.

2.

Pay attention to the timer LED.



OFF

The automatic timer is switched off.



ON

The automatic timer is switched on.



17. Switching the automatic twilight function on/off

The automatic twilight function causes the roller shutters to close automatically to their lower end point or the configured ventilation position (see page 33).

The control signals for this function are provided by a DuoFern transmitter on the DuoFern network.

1.



Press and hold the twilight button for approx. 1 second.

2.



Pay attention to the twilight LED.

OFF

The automatic twilight function is switched off.

ON

The automatic twilight function is activated.



18. Switching the automatic dawn function on/off.

The automatic dawn function causes the roller shutters to open automatically to the upper end point.

The control signals for this function are provided by a DuoFern transmitter on the DuoFern network.

1.



Press and hold the dawn button for approx. 1 second.

2.



Pay attention to the dawn LED.

OFF

The automatic dawn function is switched off.

ON

The automatic dawn function is switched on.











19. Set the ventilation position

If you do not want the roller shutters to close fully to the lower end point, you can use this function to configure an arbitrary position (e.g. as ventilation position).

When closing automatically, the roller shutters will stop at the ventilation position, however, they can subsequently be closed completely via manual operation.

The ventilation position can be changed at any time.

-  /  Move the roller shutters to the desired ventilation position and stop.
-  + 

 Save the ventilation position.
The dawn LED flashes red by way of confirmation.
- 
 +  Revoke the ventilation position.
If you want to revoke the ventilation position, first close the roller shutters fully and then save the position again. This will set the ventilation position to the lower end point.



20. Setting the motor speed for automatic functions

EN

The speed of the motor can be configured for recurring automatic functions if necessary (e.g. to reduce noise).

Recurring automatic commands are executed at the configured motor speed.

Manual movement commands and the first automatic run after the system has been operated manually are always executed at maximum motor speed..

1.  +  + 

Simultaneously press and hold the buttons for 4 seconds.

2.

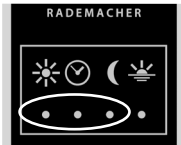

One of the three LEDs will light up red depending on the set motor speed.

3.  / 

Set the desired speed.

 =

faster

 =

slower

Pay attention to the LEDs



= low speed



= average speed



= maximum speed

Carry out a test run



4 sec.





This option remains active for approx. 4 seconds.

4.  / 

Test the set speed and noise level.

21. Erase all settings, software reset

If necessary, you can erase all of your settings and return the RolloTron Standard DuoFern system to its original factory settings.

1.  +  +  +  Simultaneously press and hold the buttons for 4 seconds.
2. All of the LEDs flash red by way of confirmation.
3. Release the buttons, subsequently all of the settings will be deleted.
End points / automatic functions / position of the sun and ventilation position and all registered DuoFern transmitters.

22. Carry out hardware reset



A hardware reset can be carried out in the event that the RolloTron Standard DuoFern fails to react to commands.

ATTENTION!

Never press the reset button when the motor is running, as otherwise the end points will be modified.



A hardware reset causes the internal power supply to the RolloTron Standard DuoFern to be briefly interrupted. All other settings are retained.

1.   Press the reset button using a sharp object (e.g. a paper clip).

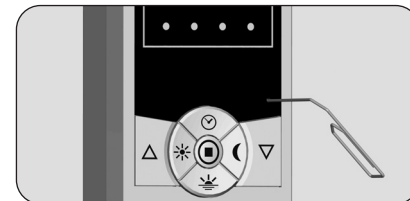



23. Removing the RolloTron Standard DuoFern (e.g. in the event of a move)

EN

1. + + + Erase all settings.
Simultaneously press and hold the buttons for 4 seconds.
2. Fully close the roller shutters.
3. Keep the button held down.
4. In doing so, pull out the belt as far as possible from the top of the RolloTron Standard DuoFern.
5. Remove the cover plate from the lower mounting holes.
You can remove the front panel by gripping the small notch in the lower side of the device.
6. Remove the mains plug from the socket.
7. Subsequently release the fastening screws and pull the RolloTron Standard DuoFern completely out of the belt box.

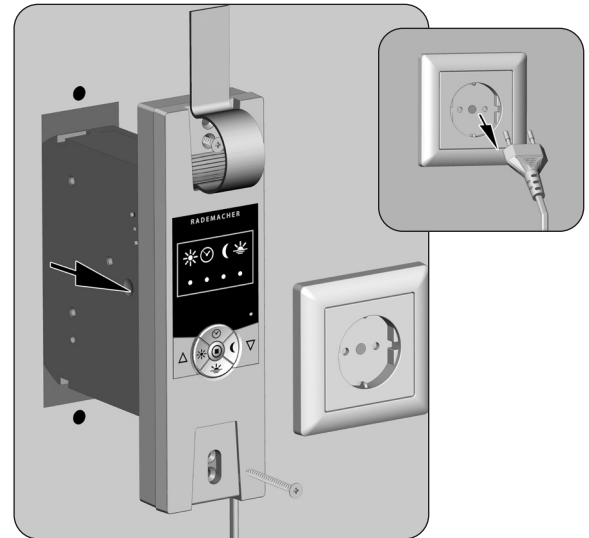



23. Removing the RolloTron Standard DuoFern (e.g. in the event of a move)

EN

8. Remove the belt compartment cover.
9. Check the position of the fastening hook and move the hook into an easily accessible position if necessary.

CAUTION!

There is a risk of injury from the reel.

- ◆ Never reach into the reel compartment when the motor is running.
- ◆ Always remove the mains plug before touching the reel compartment.

10. Subsequently remove the mains plug permanently from the socket.
11. Release the belt from the fastening hook and pull it out completely from the front of the RolloTron Standard DuoFern.

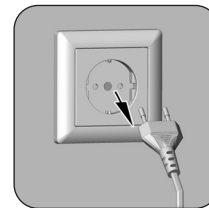
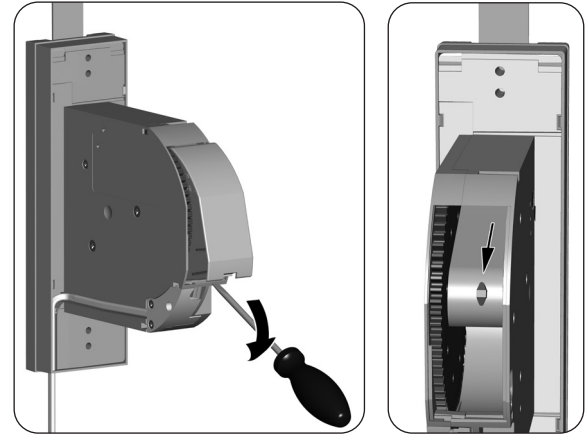



24. Removing the belt in the event of unit failure

EN

In the event that the RolloTron Standard DuoFern unit fails and the motor no longer runs, you can use the disengaging bracket provided in order to fully remove the belt from the belt winder unit, without the need for cutting it.

1. Remove the mains plug from the socket.
2. Dismantle the RolloTron Standard DuoFern as previously demonstrated on page 36.

WARNING!

There is a risk of injury as the roller shutters may slam shut or fall in an uncontrolled manner.

- ◆ Secure the roller shutters from falling.
- ◆ Hold on to the belt tightly to stop the roller shutters from slamming shut or falling in an uncontrolled manner.
- ◆ Get a second person to help you unlatch the unit.

3. Release the drive with the help of the supplied disengaging bracket.
4. Maintain pressure on the disengaging bracket and pull the belt out of the RolloTron Standard DuoFern as far as possible.

5. Release the belt from the fastening hook and pull it out completely from the RolloTron Standard DuoFern.
6. Place the disengaging bracket back in its holder.

**RolloTron
Standard
DuoFern**

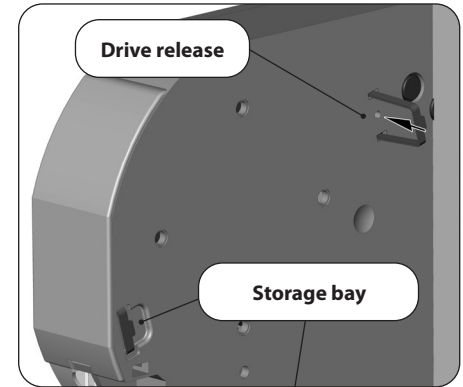

**RolloTron
Standard
DuoFern
Plus**





25. What to do if... ?

Fault	Possible cause / solution
... the RolloTron Standard DuoFern indicates no functions?	Check the power supply including connecting cable and plug.
... the RolloTron Standard DuoFern no longer reacts at the configured switching time?	The end points may not be configured. Configure the end points, see page 22.
... the roller shutters no longer stop at the configured end points?	The end points may be displaced due to elongation of the belt. Re-adjust the end points, see page 22.
... the roller shutters stop as soon as the control button is released?	The end points are not configured. Configure the end points, see page 22.
... an automated function does not work?	The automatic function may not be activated. Activate the desired automatic function, see page 29.
... the RolloTron Standard DuoFern rotates in the wrong direction?	Possibly the belt is wrapped around the reel incorrectly, see page 19.
... all of the LEDs flash successively (running light) and the RolloTron Standard DuoFern fails to operate in any direction?	The maximum running time of the drive has been exceeded, see page 5/43. The motor is too hot. The belt winder will be operational again in approx. 1 hour.



25. What to do if... ?

Fault	Possible cause / solution
... the roller shutters stop during downward travel?	a) The roller shutters may have hit an obstacle. Move the roller shutters back up and remove the obstacle.
	b) Slats have shifted out of alignment. If possible, move the roller shutters back up and realign the slats.
	c) The roller shutters scrape against the window frame inside the roller shutter box due to the lack of a pinch roller or insulation material may have come free and is jamming the roller shutters. Open the roller shutter box and rectify the fault. Lubricate any stiff areas with gliding wax if necessary.
	d) The roller shutters are too light. Increase the weight of the roller shutters by, for example, adding a piece of flat steel to the bottom slat.
... the roller shutters stop suddenly during upward travel?	a) The drive may be jammed, for example, due to the roller shutters freezing up or other obstacles.
	b) The roller shutters may not be running sufficiently smoothly. Check the roller shutters and roller shutter guides.
	c) The roller shutters may be too heavy. The maximum tractive force of the belt winder has been exceeded, see page 44.



25. What to do if... ?

Fault	Possible cause / solution
... the RolloTron Standard DuoFern no longer reacts in the morning at the configured switching time?	<p>The electronic system switched off the drive after closing the roller shutters because the deflection roller stopped turning. This is the case if:</p> <hr/> <p>a) The [Down] button was pressed for an excessive period of time during the configuration process for the lower end point. The roller shutter slats are closed, but the belt continued to wind and is no longer tight on the deflection roller.</p> <hr/> <p>b) The lower end point is displaced due to elongation of the belt. The belt may never be slack. Reconfigure the lower end point (see page 23) and ensure that the belt remains tight to the deflection roller. In doing so, the deflection roller must turn evenly.</p>
... the RolloTron Standard DuoFern fails to react properly either manually or automatically?	<p>a) The RolloTron Standard DuoFern is no longer ready for operation. Carry out a hardware reset in accordance with page 35.</p> <hr/> <p>b) If the RolloTron Standard DuoFern still fails to react after the hardware reset, carry out a software reset in accordance with the instructions on page 35. Subsequently test the RolloTron Standard DuoFern with the default factory settings.</p>

Maintenance

 **CAUTION!**

Inadequate maintenance may lead to personal injury through damage to your RolloTron Standard DuoFern and to the roller shutter system.

- ◆ Please check the RolloTron Standard DuoFern and all of your roller shutter components regularly for damage.
 - Regularly check the RolloTron Standard DuoFern for its correct functionality.
 - The shutters must not be damaged.
 - The belt must not be frayed.
 - The deflection roller on the roller shutter box must move freely.
 - The winding reel in the roller shutter box must be attached and stable. After a longer period of use, this may lose its stability.
 - ◆ Have damages components exchanged by a specialist firm.
-

Care

You can clean the RolloTron Standard DuoFern using a lightly dampened cloth. Please do not use aggressive or abrasive cleaning agents.

Supply voltage:	230 V / 50 Hz; 230 V / 60 Hz
Nominal power:	70 W
Standby power:	< 0.6 W
Nominal torque:	
- RolloTron Standard DuoFern	10 Nm
- RolloTron Standard DuoFern Plus	14 Nm
Maximum speed:	
- RolloTron Standard DuoFern	30 RPM.
- RolloTron Standard DuoFern Plus	24 RPM.
Maximum tractive force:	See page 44 (tractive force diagram)
Transient operation:	4 minutes (maximum running time)
Protection class:	II
Protection type:	IP20 (only for use in dry rooms)
Permissible ambient temperature:	0 - 40 °C
Noise pressure level (LpA):	≤ 70 dB(A)
Mains connecting cable:	2 x 0.75 mm ² (H03VVH2-F)
Transmission frequency:	434.5 MHz
Transmission power:	max. 10 mW
Range:	
- in the building:	10 to 15 m
Max. number of DuoFern transmitters:	20
Dimensions:	See page 15



28. Tractive force diagrams

EN

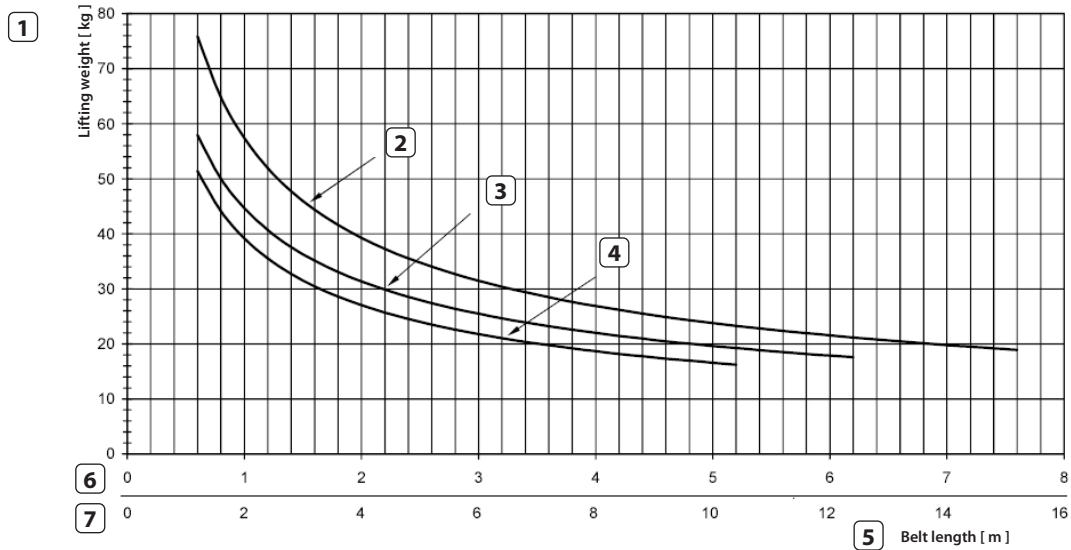

- 1 Lifting weight [Kg]
- 2 Belt thickness 1.0 mm
- 3 Belt thickness 1.3 mm
- 4 Belt thickness 1.5 mm
- 5 Belt length [m]
- 6 Belt lengths for RolloTron Standard DuoFern
- 7 Belt lengths for RolloTron Standard DuoFern Plus



29. Simplified EU Declaration of Conformity

EN



RADEMACHER Geräte-Elektronik GmbH hereby declares that the RolloTron Standard DuoFern complies with the Directives **2006/42/EC (Machinery directive)** and **2014/53/EU (Radio Equipment Directive)**.

The full text of the EU declaration of conformity is included with the product and is kept on file by the manufacturer.s.

RADEMACHER Geräte-Elektronik GmbH
Buschkamp 7
46414 Rhede (Germany)



30. Accessories

A comprehensive range of accessories is available for customising your **RolloTron Standard DuoFern** to local conditions.

Further information about our accessories is available at the following website:

www.rademacher.de/zubehoer

RADEMACHER Geräte-Elektronik GmbH provides a 36-month warranty for new systems that have been installed in compliance with the installation instructions. All construction faults, material defects and manufacturing defects are covered by the warranty.

Your statutory warranty claims shall remain unaffected by this warranty.

The following are not covered by the warranty:

- ◆ Incorrect fitting or installation
- ◆ Non-observance of the installation and operating instructions
- ◆ Improper operation or wear and tear
- ◆ External influences, such as impacts, knocks or weathering
- ◆ Repairs and modifications by third party, unauthorised persons
- ◆ Use of unsuitable accessories
- ◆ Damage caused by unacceptable excess voltages (e.g. lightning)
- ◆ Operational malfunctions caused by radio frequency overlapping and other such radio interference

For the warranty to be applicable, the new device must have been purchased through one of our approved specialist retailers. Proof of this can be provided by pre-senting a copy of the bill.

RADEMACHER shall remedy any defects, which occur within the warranty period free of charge either by repair or by replacement of the affected parts or by supply of a new replacement unit or one to the same value. There is no general extension of the original warranty period by delivery of a replacement or by repair as per the terms of the warranty.

RADEMACHER

Geräte-Elektronik GmbH
Buschkamp 7
46414 Rhede (Germany)
info@rademacher.de
www.rademacher.de

Service:

Hotline 01807 933-171*

Fax +49 2872 933-253
service@rademacher.de

* 30 seconds free of charge, subsequently 14 cents / minute from German fixed line networks and max. 42 cents / minute from German cellular networks.