



Item No.:

1423 45 19

1423 60 19 (Standard Plus)

1415 45 19 (Small belt)



Dear Customer,

EN

With your purchase of a **RolloTron Standard**, you have chosen a quality product manufactured by RADEMACHER. Thank you for the trust you have placed in us.

This roller shutter belt winder has been designed both in order to provide optimal convenience and operability as well as to ensure solidity and durability. Having applied uncompromising quality standards, and carried out thorough testing, we are proud to be able to present you with this innovative product.

It's brought to you by all the highly-qualified personnel here at RADEMACHER.



These instructions...

...describe how to install the equipment, connect the electrical system and operate your roller shutter belt winder.



Before you begin, please read these instructions through completely and follow all the safety instructions.

This manual is a component of the product. Please store it in an easily accessible place. When passing the RolloTron Standard on to a third party, this manual must be passed on as well.

Damage resulting from non-compliance with these instructions and safety instructions will void the guarantee. We assume no liability for any consequential damage.

i	Dear Customer,.....	2	14.	Automatic timer; brief description	26
1.	Hazard symbols	4	14.1	Configuring an opening and closing time	26
1.1	Levels of danger and signal words.....	4	14.2	Switching the automatic timer on/off	27
1.2	Symbols and depictions used.....	4	15.	Automated solar function; brief description	28
2.	Safety instructions.....	5	15.1	Automated solar function; configuring sensitivity	30
2.1	Proper use	6	16.	Automatic twilight function; brief description ..	31
2.2	Improper use.....	7	16.1	Automatic twilight function; configuration of sensitivity	32
2.3	Required expert knowledge of the installer.....	7	17.	Setting the motor speed for automatic functions.....	33
3.	Scope of delivery (item no. 1423 45 19) *	8	18.	Erase all settings, software reset.....	34
4.	General view (item no. 1423 45 19) *	9	19.	Carry out hardware reset.....	34
5.	Permissible roller shutter belts	10	20.	Removing the RolloTron Standard (e.g. in the event of a move)	35
6.	Functional description.....	11	21.	Removing the belt in the event of unit failure ...	37
6.1	Description of safety functions	12	22.	What to do if... ?	38
7.	General assembly instructions.....	13	23.	Information about maintenance and care of your equipment.....	41
7.1	You will need the following tools	13	24.	Technical Specifications.....	42
7.2	Preparation for installation	14	25.	Tractive force diagrams	43
8.	Safety instructions for electrical connection.....	16	26.	Simplified EU Declaration of Conformity	44
8.1	Electrical connection.....	17	27.	Accessories	44
9.	Drawing in and fastening the belt.....	18	28.	Warranty conditions.....	45
10.	Mounting the RolloTron Standard.....	20			
11.	End point adjustment	22			
12.	Manual operation	24			
13.	Automatic mode; brief description	25			
13.1	Switch all automatic functions on / off simultaneously	25			

i 1. Hazard symbols



Danger of fatal electric shock



Danger area / dangerous situation

i 1.1 Levels of danger and signal words

! DANGER!

This hazard will result in serious injury or death if not avoided.

! WARNING!

This hazard may result in serious injury or death if not avoided.

! CAUTION!

This hazard may result in minor or moderate injury if not avoided.

! ATTENTION!

This hazard may lead to property damage.

i 1.2 Symbols and depictions used

- 1. Steps to be taken
- 2.

◆ Itemisation

- 1. List



Please read the respective manual



further useful information



The use of defective equipment can lead to personal injury and damage to property (electric shocks, short circuiting).

- ◆ Never use defective or damaged equipment.
- ◆ Check the device and mains cable beforehand for damage.
- ◆ Should you discover damage to the equipment, please consult our customer service department (see page 48).



Incorrect use leads to an increased risk of injury.

- ◆ Train all personnel to use the RolloTron Standard safely.
- ◆ This device may be used by children from 8 years of age upwards as well as by persons with reduced physical, sensory or mental capacities or with lack of experience and knowledge if they are supervised or have been instructed on how to use the device safely and if they understand what dangers may result from this.
- ◆ Children must not play with the device.
- ◆ Cleaning and user maintenance may not be carried out by children without supervision.

- ◆ Watch the moving roller shutters whilst carrying out the settings and during normal operation, and keep other people away from the area to avoid injury in the event the shutters suddenly slip.
- ◆ Carry out all cleaning work on the roller shutters whilst the device is disconnected from the mains power.

The mains socket and plug must be easily accessible at all times.



Exceeding the maximum permissible running time (KB) can overload and damage the RolloTron Standard.

- ◆ The maximum permissible running time for a cycle may not be exceeded when the equipment is in operation. For this reason, the RolloTron Standard has an automatic **running time limit (KB)** of four minutes.
- ◆ If the running time limit is triggered, then the RolloTron Standard must be left for at least 12 minutes to cool down. Full operational availability is re-established after approx. one hour.



2. Safety instructions

EN

According to DIN EN 13659, it is necessary to determine that the movement conditions for the shutters are maintained in accordance with EN 12045.



- ◆ The displacement must amount to at least 40 mm on the lower edge in the rolled-out position with a force of 150 N in the upwards direction.
- ◆ In doing so, it must be ensured that the extending speed of the shutters for the final 0.4 m is less than 0.15 m/s.



2.1 Proper use

Only use the RolloTron Standard for opening and closing roller shutters with a permissible belt.



Mechanical locks of any kind are not suitable for automated operation with this device.

Only use original spare parts from RADEMACHER.

- ◆ By doing so, you avoid the risk of malfunctions and damage to your RolloTron Standard.
- ◆ As the manufacturer, we provide no guarantee for the use of third-party components and accept no liability for consequential damage resulting from such.
- ◆ All repairs to the RolloTron Standard must be undertaken by authorised customer service personnel.

Operating conditions

- ◆ Only operate the RolloTron Standard in dry rooms.
- ◆ A 230 V / 50 Hz power supply, together with a site-provided isolating device (fuse, MCB), must be permanently available at the installation location.
- ◆ An easily accessible 230 V / 50 Hz socket must be available at the installation site if the enclosed connecting cable with Euro plug is being used.
- ◆ The roller shutters must run up and down smoothly and should not stick.
- ◆ The mounting surface for the RolloTron Standard must be flat.



2.2 Improper use

Using the RolloTron Standard for purposes other than previously mentioned is impermissible and is regarded as improper use.



There is a risk to life caused through short circuiting and electric shocks if the RolloTron Standard is used outside.

- ◆ Never install or operate the RolloTron Standard outside.



2.3 Required expert knowledge of the installer

The electrical connection, installation and commissioning of the RolloTron Standard must only be carried out by a qualified electrician in accordance with the instructions in this manual.



3. Scope of delivery (item no. 1423 45 19) *

EN

* also applies to item numbers 1423 60 19 / 1415 45 19

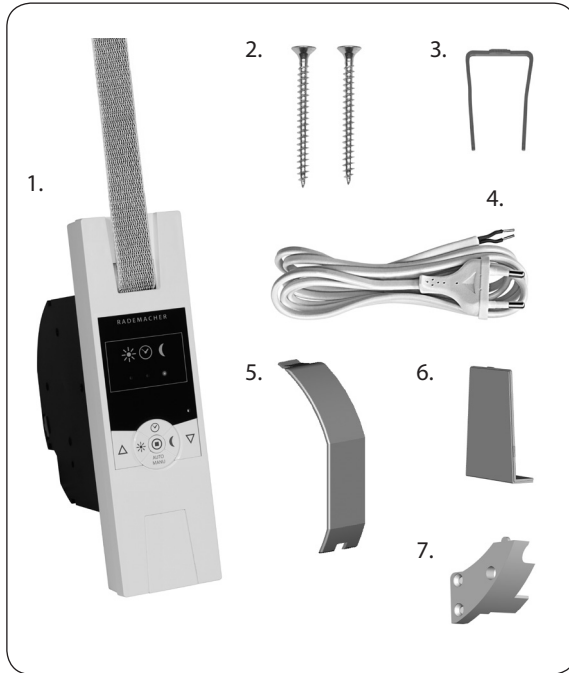

Legend

1. Belt Winder RolloTron Standard or Standard Plus
2. 2 x assembly screws (4 x 55 mm)
3. Disengaging bracket (in housing)
4. Connection cable with Euro-plug
5. Reel compartment cover
6. Cover plate
7. Traction relief mechanism including assembly screws

After unpacking please check and compare ...

the contents of the package with the above specified.

Check the details on the type plate

Check that the voltage / frequency on the type plate corresponds to the local mains conditions.



4. General view (item no. 1423 45 19) *

EN

* also applies to item numbers 1423 60 19 / 1415 45 19

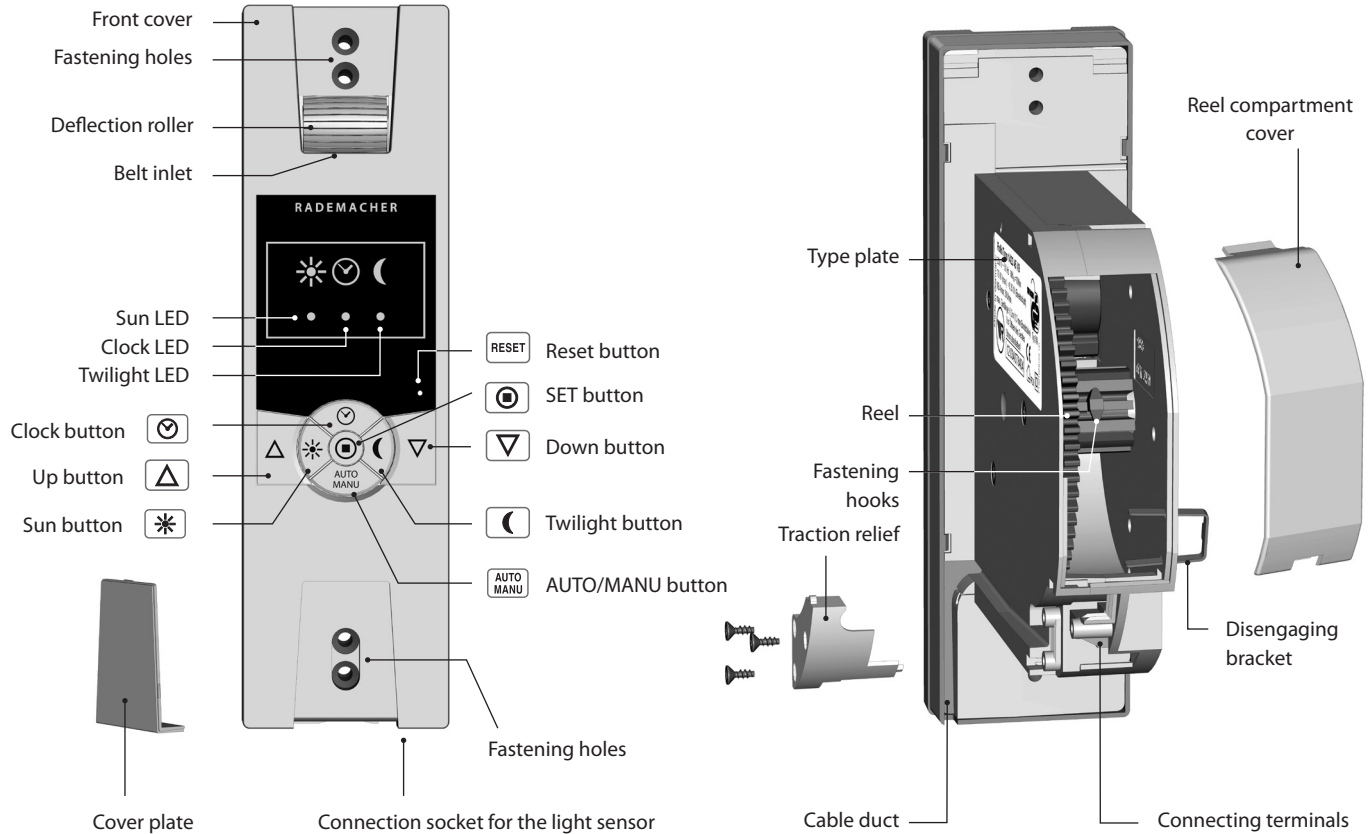



5. Permissible roller shutter belts

EN

ATTENTION!

The RolloTron Standard may be damaged if excessively long belts are used.

Only use belts of the permissible lengths.



The specifications are intended for guidance only and apply to an ideal installation situation. The actual values may vary due to local conditions.

Table 1: Permissible roller shutter belts

RolloTron: Item No:		Standard (Small belt) 1415 45 19	Standard 1423 45 19	Standard Plus 1423 60 19
Belt width:	Belt thick- ness:	Maximum belt length		
15 mm (Small belt)	1.0 mm	7.6 m	---	---
	1.0 mm	---	7.6 m	15 m
23 mm (Standard belt)	1.3 mm	---	6.2 m	12 m
	1.5 mm	---	5.2 m	11 m

Table 2: Permissible roller shutter surface area (m²)

Roller shutter type:	Weight/m²	Permissible roller shutter surface area (m²)		
Plastic roller shutters	(4.5 kg/m ²)	Approx. 6 m ²	Approx. 6 m ²	Approx. 10 m ²
Aluminium and wooden roller shutters	(10.0 kg/m ²)	Approx. 3 m ²	Approx. 3 m ²	Approx. 6 m ²



6. Functional description

The RolloTron Standard is a roller shutter drive designed for use inside. It is fitted as a flush-mounted device and the power supply is provided via the enclosed connecting cable with plug or a fixed installed lead.

Automatic LED dimming

The RolloTron Standard is equipped with automatic dimming LEDs to reduce the light intensity (e.g. bedrooms). The LEDs dim as the roller shutters are lowered.

Features and control options:

- ◆ Manual operation (MANU)
- ◆ Automatic mode (AUTO), with a separate switching time for UP (Δ) and DOWN (∇)
- ◆ AUTO/MANU - switchover
- ◆ Automated solar function
- ◆ Automatic darkness function
- ◆ End point setting
- ◆ Permanent storage of the settings
- ◆ Obstacle detection
- ◆ Overload cut-off
- ◆ Soft-start and Soft-stop
- ◆ Setting the motor speed for automatic functions
- ◆ Automatic LED dimming

Soft-start / Soft-stop

The RolloTron Standard is equipped with a Soft-start / Soft-stop function. Gentle starting and stopping serves to protect the belt winder mechanics and the belt.

Obstacle detection

The movement of the belt is monitored. If the roller shutters hit an obstacle in the DOWN (▽) direction, the belt will stop moving and the belt winder is switched off.



Once the system has switched off, it is no longer possible to directly operate the drive in the same direction.

- ◆ Run the belt winder back in the opposite direction and remove any possible obstacle.
- ◆ Subsequently it is possible to operate the drive in the original direction again.



There is a risk of injury if the obstacle detection is not working.

- ◆ The belt must be wound on as evenly as possible to ensure safe and correct functioning of the obstacle detection function.
- ◆ Please ensure that the belt winds as straight and evenly as possible into the device during its subsequent cycle after the obstacle detection system has triggered.

Overload cut-off

The RolloTron Standard is equipped with an overload cut-off system.

If the drive jams in the UP (△) cycle (for example, due to ice), the belt winder will also switch off.

- ◆ Once the cause for the overload has been rectified, the drive is fully operational in both directions.

i 7. General assembly instructions



Poor routing of the belt can cause the belt to fail and leads to unnecessary loads on the RolloTron Standard.

- ◆ Install the belt winder so that the belt runs as straight as possible into the device, in order to avoid unnecessary friction and wear.



Incorrect installation can lead to property damage.

- ◆ Strong forces are exerted during operation of the system which require secure installation on a firm base.

i 7.1 You will need the following tools

- ◆ Screwdriver
- ◆ Scissors
- ◆ Carpenter's gauge or measuring tape
- ◆ Pen

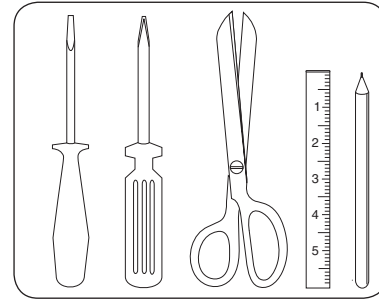



7.2 Preparation for installation

EN

1. Take measurements.
Check that the belt box has sufficient space to house the RolloTron Standard.

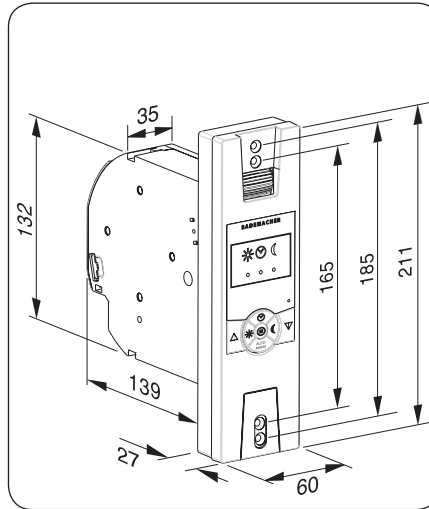

All dimensions in mm

RolloTron Standard

Item no.:

1415 45 19 (Small belt)

1423 45 19 (Standard belt)

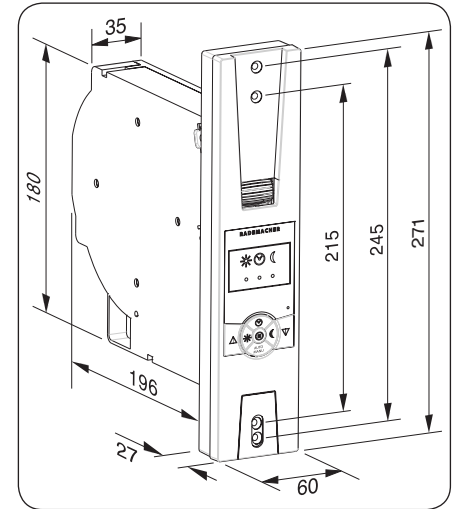

All dimensions in mm

RolloTron Standard Plus

Item no.:

1423 60 19 (Standard belt)



7.2 Preparation for installation

2. Remove the old belt winder, if you are carrying out a conversion to an existing roller shutter system.

2.1 Let the roller shutter move fully down, until the slats are completely closed.

2.2 Remove the old belt winder and unreel the belt.

CAUTION!

There is a risk of injury from the pre-tensioned springs on the old belt winder.

- ◆ The spring unit can suddenly recoil when it is removed.
- ◆ Hold the spring unit firmly when loosening the belt and allow it to recoil slowly until the spring unit has completely unwound.

3. Prepare the belt.

3.1 Cut the belt off approx. 20 cm under the belt box.

3.2 Fold the end of the belt over by approx. 2 cm and cut a short slit in the centre. This enables you to subsequently hook the belt onto the reel.

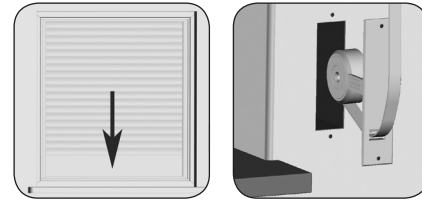

Recommendation

The belt must run as straight and freely as possible. For stiff roller shutters, mount a deflection roller on the belt box. This helps to prevent unnecessary friction and wear to the belt.

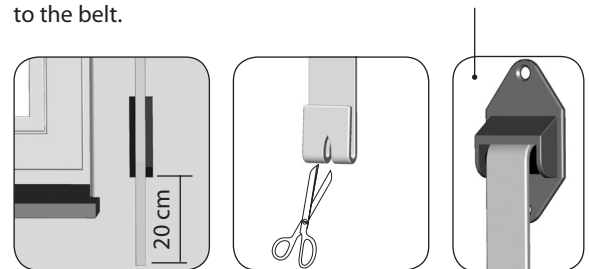

Accessories, see page 44.



8. Safety instructions for electrical connection

EN



DANGER!



Danger due to electric shock when working on all electrical systems.

- ◆ Carry out all installation and connection work only in an isolated, zero-volts state.
- ◆ Disconnect all phases of the mains power supply cable and secure it to prevent any reconnection.
- ◆ Check the system for a zero-voltage status.



The electrical connection for the RolloTron Standard can be made either with the supplied connecting cable or via a fixed laid cable.



8.1 Electrical connection

1. Connect the provided connecting cable to the connecting terminals of the RolloTron Standard.
The colour coding is irrelevant for the installation.

⚠ WARNING!



Damaged cables can cause short circuits.

- ◆ Pay attention that cables are laid safely.
- ◆ The connecting cable may not be pinched when screwing on the belt winder as this could lead to damage.

2. Lay the connecting cable to the RolloTron Standard in a cable duct.
3. Finally, screw on the traction relief mechanism with the screws provided.

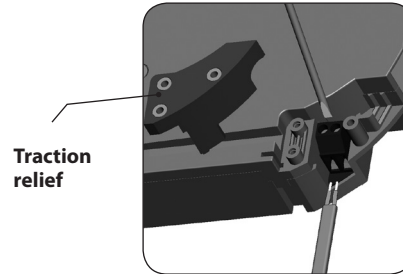

RolloTron Standard

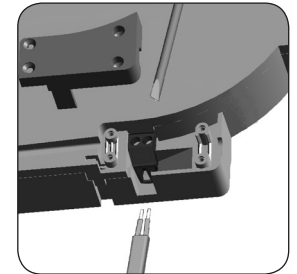

RolloTron Standard Plus

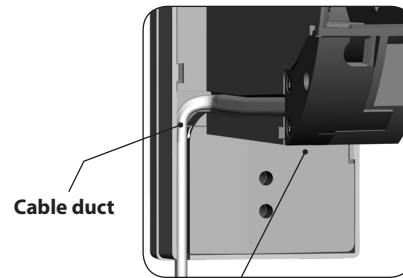

Traction relief

i 9. Drawing in and fastening the belt

1. Insert the mains plug into the socket.

⚠ CAUTION!

There is a risk of injury from the reel.

Never reach into the reel compartment when the motor is running.

2. **⚠** Press the UP button until the fastening hooks are easily accessible in the reel compartment.



As no end points have been set yet, the drive will stop as soon as you release the button.

3. Always remove the mains plug from the socket.

4. Next, draw-in the belt into the RolloTron Standard from the top.

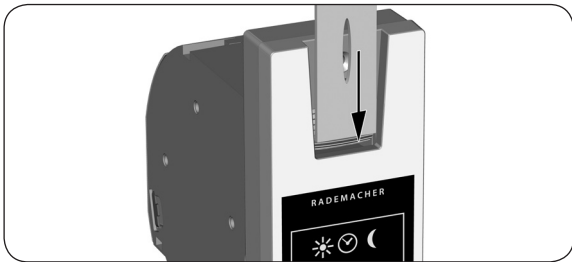
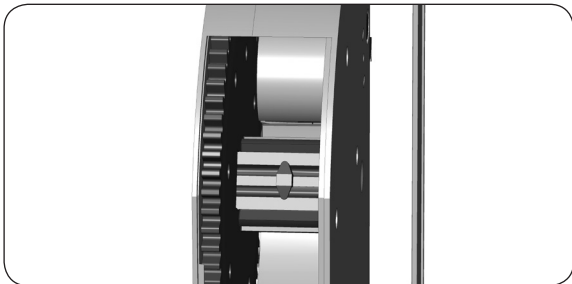



9. Drawing in and fastening the belt

5. Continue to feed the belt into the device as shown in the bottom right sectional diagram and subsequently slide the belt over the fastening hooks from above.
6. Re-insert the mains plug into the socket.
7.  Press the UP button until the belt has wound around the reel once completely.
8. Pull the belt tight when winding, so that the deflection roller turns at the same time.
9. Finally remove the mains plug from the socket again.
10. Finally, place the provided reel compartment cover onto the reel compartment.

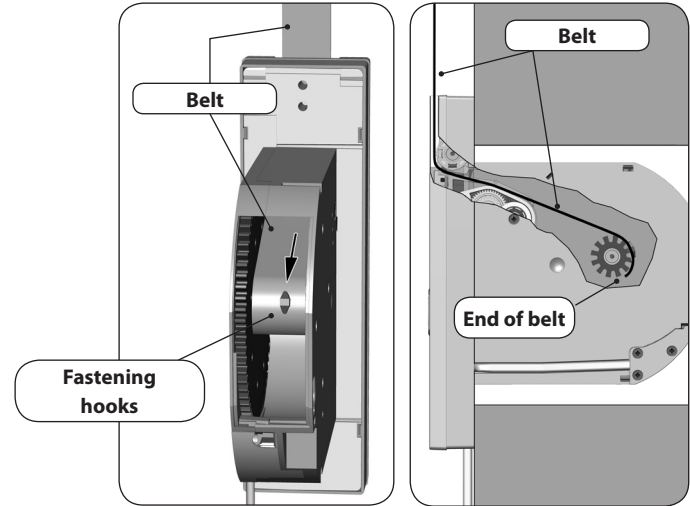

**Belt path in
RolloTron Standard**



10. Mounting the RolloTron Standard

Mount the RolloTron Standard as straight as possible, so that the belt can wind correctly.

Ensure that the RolloTron Standard sits freely in the belt box and that it is not in contact with the masonry, otherwise noise will be generated during operation.

1. Slide the RolloTron Standard into the belt box and screw it tight using the screws provided.

 **WARNING!**



A damaged connecting cable may cause a short circuit.

Ensure that the connecting cable is laid correctly inside the cable duct, otherwise it can be crushed and damaged when the cover is screwed in place.

2. Slide the enclosed cover plate over the lower mounting holes.

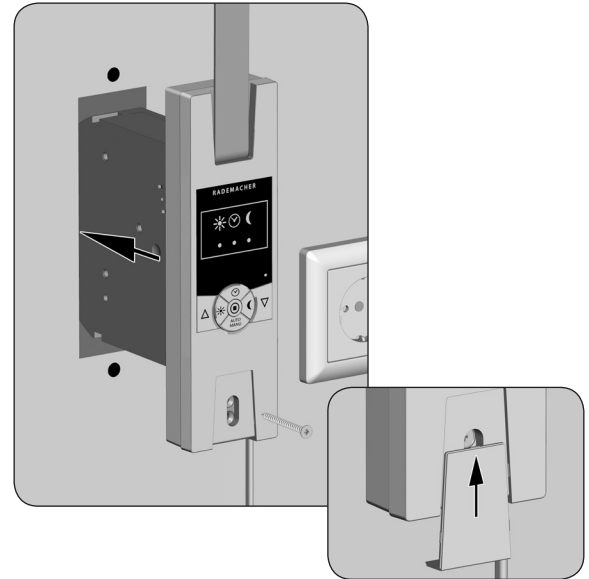



10. Mounting the RolloTron Standard

3. Mount the light sensor (not included, see page 44, Accessories).

- 3.1 Insert the light sensor plug into the designated connection socket at the bottom of the RolloTron Standard.

- 3.2 Subsequently secure the light sensor to the window pane using the sucker.



The position of the light sensor on the window pane determines the point at which the roller shutters will close to in the event of sunlight.

4. Re-insert the mains plug into the 230 V / 50 Hz socket. This completes the installation process.

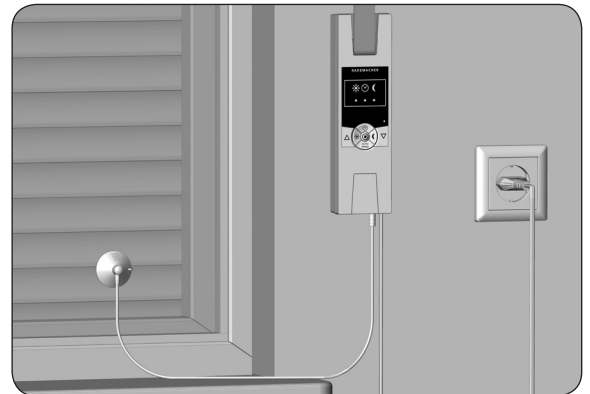
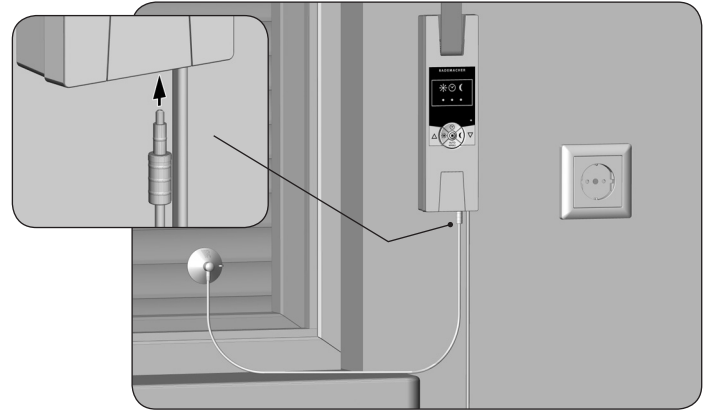



11. End point adjustment

Additional information about configuring the end points



The end points must be configured in order that the roller shutters stop at the desired upper and lower positions. It is imperative that both end points are configured, otherwise malfunctions may occur.





If the RolloTron Standard is operated without an end point setting, the drive will continue to run for as long as one of the two control buttons is actuated.

The automatic functions remain blocked until the end point setting is configured.

Set the upper end point

1.  +  Simultaneously press and hold the buttons.
The roller shutters travel up.

- 1.1 Tighten the belt slightly, until it is tensioned by the weight of the roller shutters.

2.  +  Release the buttons as soon as the roller shutter achieves the desired position for the upper end point.
The roller shutter stops and the upper end point is stored.



ATTENTION!



Setting the wrong upper end point may lead to overload or damage the RolloTron Standard or the drive.



- ◆ Do not set the upper end point right up to the limit stop.
- ◆ Release the button promptly and never allow it to extend beyond the respective end point.



11. End point adjustment

Set the lower end point

3.  +  Simultaneously press and hold the buttons.
The roller shutters travel down.

4.  +  Release the buttons...
...as soon as the roller shutter achieves the desired position for the lower end point. The roller shutter stops and the lower end point is stored.



Please ensure that the belt is not excessively slack when reaching the lower end point.

Changing or correcting the end points

5. Move the roller shutters to the centre position and configure the respective end point again.







After a period of time it may be necessary to reconfigure the end points as the belt may elongate during the process of operation.



12. Manual operation

Manual operation is always possible and has priority over the programmed automatic functions.

1.  Open the roller shutters.
Briefly pressing the button causes the roller shutters to move to the upper end point.
2.  or  Causes the roller shutters to stop in the interim.
3.  Closing the roller shutters.
Briefly pressing the button causes the roller shutters to move to the lower end point.

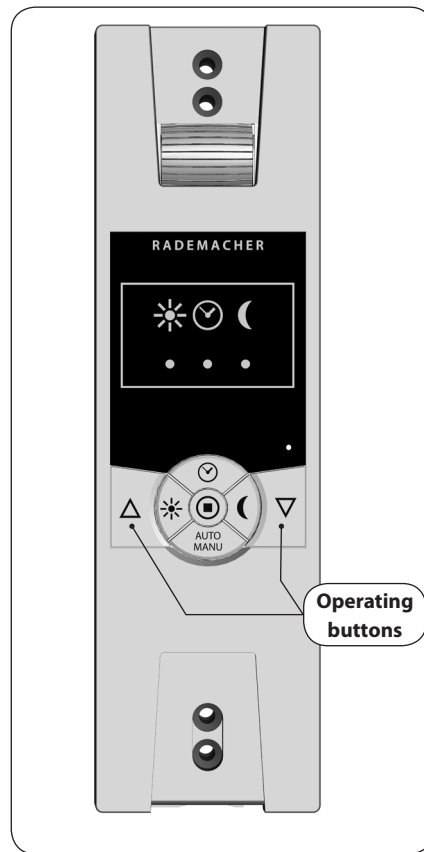

13. Automatic mode; brief description

The RolloTron Standard features three automatic functions:

- ◆ Automated solar function
- ◆ Automatic timer
- ◆ Automatic twilight function

All of the automatic functions can be combined as well as independently activated and deactivated on the RolloTron Standard.

The status of each automatic function is indicated by the respective LED. The automatic timer can only be activated if a time setting has previously been programmed.

13.1 Switch all automatic functions on / off simultaneously

1.  Press and hold the [AUTO/MANU] button for approx. 1 second.
2. All previously activated automatic functions will be simultaneously switched on or off.
3. Observe the LEDs indicating the status of the automatic functions.
4. Once automatic mode is deactivated, it is only possible to operate the system manually.



14. Automatic timer; brief description

The same switching times every day of the week.

You can set an opening and closing time for your belt winder which will apply to all days of the week. Once this time is reached, the roller shutters will open or close automatically.

Changing the switching times

You can change the switching time settings at any time. Please note that each new setting deletes the previous setting.







In order to set the switching times, you must carry out this step once at the time that the roller shutters are to open or close.

- ◆ For example, carry out the step at 8:00 o'clock in the morning if you want the roller shutters to open at 8:00 AM every day.
- ◆ You must set at least one switching time, in order to activate the automatic timer.
- ◆ Your changes will not be executed until the next day when you configure opening and / or closing times.







14.1 Configuring an opening and closing time

Configure an opening time (△) (e.g. at 8:00 AM)

1.  +  Simultaneously briefly press the buttons.
2.  The timer LED flashes the roller shutters travel upwards.
 The automatic timer is now activated. Your roller shutters will open automatically every day at 8:00 AM.

Configure a closing time (▽) (e.g. at 20:30 in the evening)

1.  +  Simultaneously briefly press the buttons.
2.  The timer LED flashes the roller shutters travel downwards.
 The automatic timer is now activated. Your roller shutters will close automatically every day at 20:30.



14.2 Switching the automatic timer on/off

You can toggle between automatic and manual modes at any time if required.



Manual operation of the roller shutters is possible at any time, regardless of the automatic settings.

1.

Press the timer button for approx. 1 second.

2.

Pay attention to the timer LED.



OFF

The automatic timer is switched off.



ON

The automatic timer is switched on.



Flashing

After previous power failure, if at least one switching time has previously been configured.



In the event of power failure, the switching times will be extended by the duration of the power failure, and therefore may require reconfiguration.



15. Automated solar function; brief description

The automated solar function enables brightness-dependent control of the roller shutters in combination with the light sensor. To do this, the light sensor is secured to the window pane with a sucker and then plugged into the RolloTron Standard.

Automated solar function

Automatic moving up and down of the roller shutter once a set limit is exceeded. The roller shutter end position can be freely selected by changing the light sensor position.



Example installation

Light sensor, see page 44 (accessories)



15. Automated solar function; brief description

Automatic lowering

If the sensor detects uninterrupted sunlight for 10 minutes, the shutter will descend until its shadow covers the light sensor.

Automatic clearing

After approx. 20 minutes, the roller shutter is automatically raised a small amount to uncover the sensor. If the sun continues to shine, then the roller shutter remains in this position. If the brightness falls below the set limit, it will return to the upper end point.



The above mentioned delay times can be exceeded in the event of changing weather conditions.

The automated solar function will be terminated and must be reactivated if required after the following events:

- ◆ After manual actuation.
- ◆ After execution of an automatic function.
- ◆ After the upper end point is reached.

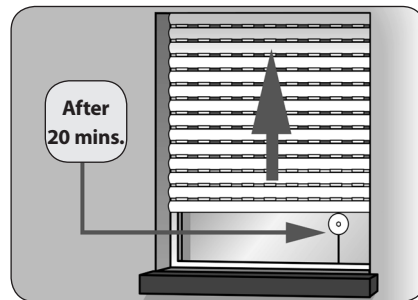
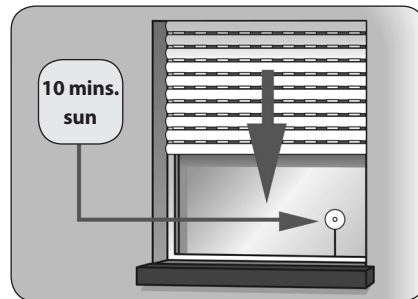



15.1 Automated solar function; configuring sensitivity

EN

The automated solar function is switched on by setting or changing the sensitivity.

Configure the brightness at the level which the blinds should be closed.



If you do not intend to use the automated solar function, it is necessary to remove the solar sensor from the window pane and protect it from the sunlight or remove the connector from the RolloTron Standard device.

Set the current brightness as set limit and switch on the automated solar function.

1. + Simultaneously press the buttons.
The current brightness is now set as the set limit and the automated solar function is activated. If this value is exceeded, the roller shutters will roll down to the light sensor.

2.

Pay attention to the solar LED.



OFF

Automated solar function OFF



ON

Automated solar function ON



Slowly flashing...

- ◆ if the set limit is exceeded.
- ◆ if the current brightness value is within the measured range while configuring the set limit.



Rapid flashing

If the current brightness value is outside the measuring range, the set limit is set to the measured range limit.

3.

You can switch the automated solar function on and off as required.

In order to do so, press and hold the sun button for approx. 1 second.



16. Automatic twilight function; brief description

The automatic twilight function causes the roller shutters to close automatically under the following conditions:

- ◆ If the automatic twilight function is activated.
- ◆ If twilight is detected for a minimum of 15 seconds.
- ◆ If the light sensor has been mounted and plugged into the RolloTron Standard.

Automatic lowering

At twilight, the roller shutters will lower to the lower end point after approx. 15 seconds. The roller shutters will open again once the configured opening time is reached or in the event of a manual UP command.

The required twilight limit is configurable.



If the roller shutters are to be lowered as a result of the automatic twilight function, then you must either set the closing time to a time after dusk (see example).

If an automatic closing command is given before twilight triggers, then the automatic twilight function will not be executed.

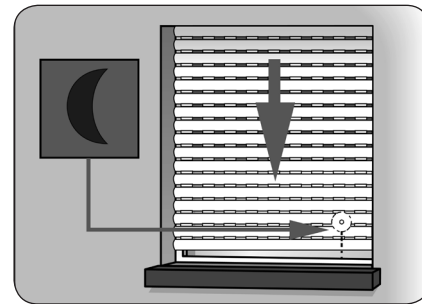

Example	1	/ 2
Automatic closing time:	23:00 hours	/ 19:30 hours
Onset of dusk:	20:30 hours	/ 20:30 hours
Your roller shutters will close automatically at:	20:30 hours	/ 19:30 hours



16.1 Automatic twilight function; configuration of sensitivity

EN



The automatic twilight function is switched on by setting or changing the sensitivity.

Configure the brightness at the level (twilight) which the blinds should be closed.



If you intend not to use the automatic twilight function, it is necessary to unplug the light sensor from the RolloTron Standard device or deactivate the automatic twilight function.

Set the current brightness (twilight) as set limit and switch on the automatic twilight function.

1.  +  Simultaneously press the buttons.
The current brightness is now set as the set limit and the automatic twilight function is activated. If this value is exceeded, the roller shutters will roll down to the lower endpoint.

2.  Pay attention to the twilight LED.



OFF

Automatic twilight function OFF



ON

Automatic twilight function ON



Slowly flashing...

- ◆ if the set limit is exceeded.
- ◆ if the current brightness value is within the measured range while configuring the set limit.



Rapid flashing

If the current brightness value is outside the measuring range, the set limit is set to the measured range limit.

3. 

You can switch the automatic twilight function on and off as required.

In order to do so, press and hold the twilight button for approx. 1 second.



17. Setting the motor speed for automatic functions

The speed of the motor can be configured for recurring automatic functions if necessary (e.g. to reduce noise).

Recurring automatic commands are executed at the configured motor speed.

Manual movement commands and the first automatic run after the system has been operated manually are always executed at maximum motor speed..

Pay attention to the LEDs



= low speed



= average speed



= maximum speed

1. + +

Simultaneously press and hold the buttons for 4 seconds.

- 2.

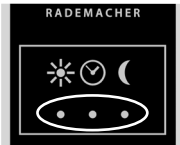

One of the three LEDs will light up red depending on the set motor speed.

- 3.



Set the desired speed.



faster



slower

4. Carry out a test run.





This option remains active for approx. 4 seconds.



Test the set speed and noise level.

18. Erase all settings, software reset

If necessary, you can erase all of your settings and return the RolloTron Standard system to its original factory settings.

1.  +  +  +  Simultaneously press and hold the buttons for 4 seconds.
2. All of the LEDs flash red by way of confirmation.
3. Release the buttons, subsequently all of the settings will be deleted.
End points / switching times / automated solar function / automatic twilight function.

19. Carry out hardware reset



A hardware reset can be carried out in the event that the RolloTron Standard fails to react to commands.

ATTENTION!

Never press the reset button when the motor is running, as otherwise the end points will be modified.



A hardware reset causes the internal power supply to the RolloTron Standard to be briefly interrupted. The opening and closing times must be reconfigured accordingly. All other settings are retained.



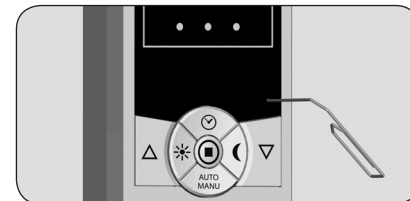



1.   Press the reset button using a sharp object (e.g. a paper clip).





20. Removing the RolloTron Standard (e.g. in the event of a move)

EN

-  +  +  +  Erase all settings.
Simultaneously press and hold the buttons for 4 seconds.
-  Fully close the roller shutters.
-  Keep the button held down.
- In doing so, pull out the belt as far as possible from the top of the RolloTron Standard.
- Remove the cover plate from the lower mounting holes.
You can remove the front panel by gripping the small notch in the lower side of the device.
- Remove the mains plug from the socket.
- Subsequently release the fastening screws and pull the RolloTron Standard completely out of the belt box.

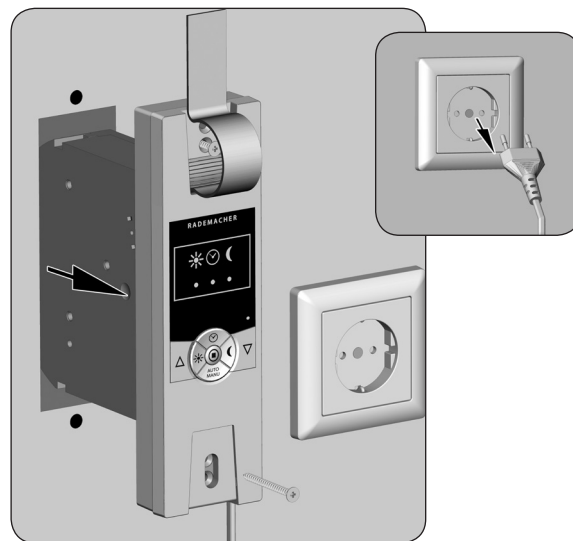



20. Removing the RolloTron Standard (e.g. in the event of a move)

EN

8. Remove the belt compartment cover.
9. Check the position of the fastening hook and move the hook into an easily accessible position if necessary.

CAUTION!

There is a risk of injury from the reel.

- ◆ Never reach into the reel compartment when the motor is running.
- ◆ Always remove the mains plug before touching the reel compartment.

10. Subsequently remove the mains plug permanently from the socket.
11. Release the belt from the fastening hook and pull it out completely from the front of the RolloTron Standard.

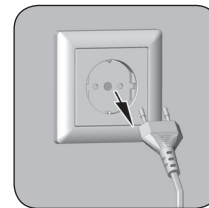
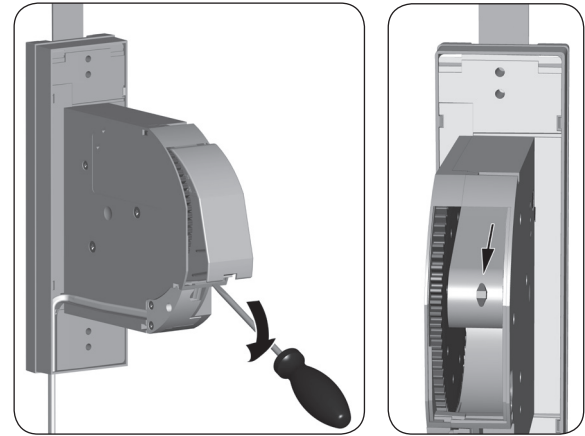

In the event that the RolloTron Standard unit fails and the motor no longer runs, you can use the disengaging bracket provided in order to fully remove the belt from the belt winder unit, without the need for cutting it.

1. Remove the mains plug from the socket.
2. Dismantle the RolloTron Standard as previously demonstrated on page 35.

⚠ WARNING!

There is a risk of injury as the roller shutters may slam shut or fall in an uncontrolled manner.

- ◆ Secure the roller shutters from falling.
- ◆ Hold on to the belt tightly to stop the roller shutters from slamming shut or falling in an uncontrolled manner.
- ◆ Get a second person to help you unlatch the unit.

3. Release the drive with the help of the supplied disengaging bracket.
4. Maintain pressure on the disengaging bracket and pull the belt out of the RolloTron Standard as far as possible.

5. Release the belt from the fastening hook and pull it out completely from the RolloTron Standard.
6. Place the disengaging bracket back in its holder.

**RolloTron
Standard**

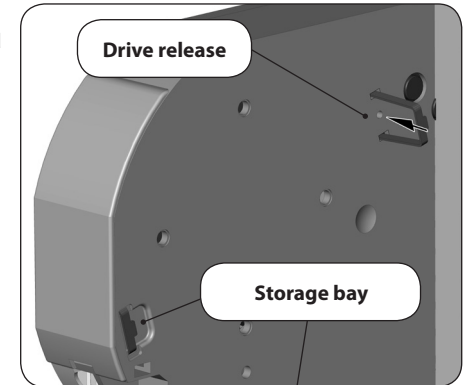

**RolloTron
Standard
Plus**





22. What to do if... ?

Fault	Possible cause / solution
... the RolloTron Standard indicates no functions?	Check the power supply including connecting cable and plug.
... the RolloTron Standard no longer reacts at the configured switching time?	a) There may have been a power failure. Reconfigure the switching times, see page 26
	b) The end may points are not configured. Configure the end points, see page 22.
... the timer LED flashes?	There may have been a power failure. Reconfigure the switching times, see page 26
... the roller shutters no longer stop at the configured end points?	The end points may be displaced due to elongation of the belt. Re-adjust the end points, see page 22.
... the roller shutters stop as soon as the control button is released?	The end points are not configured. Configure the end points, see page 22.
... the automated solar function does not work?	a) Check whether the sun sensor is attached to the window pane.
	b) Is the sunlight not bright enough or is the sensor excessively darkened as a result of shading?
	c) Check the sun sensor connecting cable for damage.
	d) Is the plug properly connected to the device?
... the RolloTron Standard rotates in the wrong direction?	Possibly the belt is wrapped around the reel incorrectly, see page 18.



22. What to do if... ?

Fault	Possible cause / solution
... the roller shutters stop during downward travel?	a) The roller shutters may have hit an obstacle. Move the roller shutters back up and remove the obstacle.
	b) Slats have shifted out of alignment. If possible, move the roller shutters back up and realign the slats.
	c) The roller shutters scrape against the window frame inside the roller shutter box due to the lack of a pinch roller or insulation material may have come free and is jamming the roller shutters. Open the roller shutter box and rectify the fault. Lubricate any stiff areas with gliding wax if necessary.
	d) The roller shutters are too light. Increase the weight of the roller shutters by, for example, adding a piece of flat steel to the bottom slat.
... the roller shutters stop suddenly during upward travel?	a) The drive may be jammed, for example, due to the roller shutters freezing up or other obstacles.
	b) The roller shutters may not be running sufficiently smoothly. Check the roller shutters and roller shutter guides.
	c) The roller shutters may be too heavy. The maximum tractive force of the belt winder has been exceeded, see page 43.



22. What to do if... ?

Fault	Possible cause / solution
... all of the LEDs flash successively (running light) and the RolloTron Standard fails to operate in any direction?	<p>The maximum running time of the drive has been exceeded, see page 5/42.</p> <p>The motor is too hot. The belt winder will be operational again in approx. 1 hour.</p>
... the RolloTron Standard no longer reacts in the morning at the configured switching time?	<p>The electronic system switched off the drive after closing the roller shutters because the deflection roller stopped turning. This is the case if:</p> <ul style="list-style-type: none"><li data-bbox="805 452 1520 569">a) The [Down] button was pressed for an excessive period of time during the configuration process for the lower end point. The roller shutter slats are closed, but the belt continued to wind and is no longer tight on the deflection roller.<li data-bbox="805 569 1520 742">b) The lower end point is displaced due to elongation of the belt. The belt may never be slack. Reconfigure the lower end point (see page 23) and ensure that the belt remains tight to the deflection roller. In doing so, the deflection roller must turn evenly.
... the RolloTron Standard fails to react properly either manually or automatically?	<ul style="list-style-type: none"><li data-bbox="805 750 1520 824">a) The RolloTron Standard is no longer ready for operation. Carry out a hardware reset in accordance with page 34.<li data-bbox="805 824 1520 946">b) If the RolloTron Standard still fails to react after the hardware reset, carry out a software reset in accordance with the instructions on page 34. Subsequently test the RolloTron Standard with the default factory settings.

Maintenance

 **CAUTION!**

Inadequate maintenance may lead to personal injury through damage to your RolloTron Standard and to the roller shutter system.

- ◆ Please check the RolloTron Standard and all of your roller shutter components regularly for damage.
 - Regularly check the RolloTron Standard for its correct functionality.
 - The shutters must not be damaged.
 - The belt must not be frayed.
 - The deflection roller on the roller shutter box must move freely.
 - The winding reel in the roller shutter box must be attached and stable. After a longer period of use, this may lose its stability.
 - ◆ Have damages components exchanged by a specialist firm.
-

Care

You can clean the RolloTron Standard using a lightly dampened cloth. Please do not use aggressive or abrasive cleaning agents.



24. Technical Specifications

Supply voltage:	230 V / 50 Hz; 230 V / 60 Hz
Nominal power:	70 W
Standby power:	< 0.35 W
Nominal torque:	
- RolloTron Standard	10 Nm
- RolloTron Standard Plus	14 Nm
Maximum speed:	
- RolloTron Standard	30 RPM.
- RolloTron Standard Plus	24 RPM.
Maximum tractive force:	See page 43 (tractive force diagram)
Transient operation:	4 minutes (maximum running time)
Protection class:	II
Protection type:	IP20 (only for use in dry rooms)
Number of switching times:	2 (UP and DOWN)
Automated solar function configurable range:	4,000 to 40,000 Lux
Automatic twilight control configurable range:	4 to 40 Lux
Permissible ambient temperature:	0 - 40 °C
Noise pressure level (LpA):	≤ 70 dB(A)
Mains connecting cable:	2 x 0.75 mm ² (H03VVH2-F)
Dimensions:	See page 14



25. Tractive force diagrams

EN

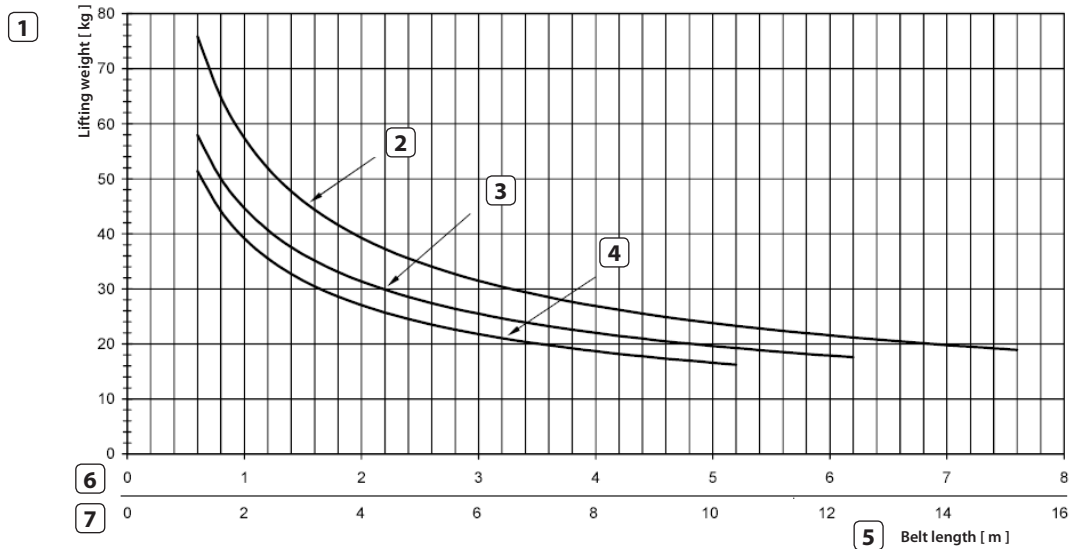

- 1 Lifting weight [Kg]
- 2 Belt thickness 1.0 mm
- 3 Belt thickness 1.3 mm
- 4 Belt thickness 1.5 mm
- 5 Belt length [m]
- 6 Belt lengths for RolloTron Standard
- 7 Belt lengths for RolloTron Standard Plus



26. Simplified EU Declaration of Conformity

EN



RADEMACHER Geräte-Elektronik GmbH hereby declares that the RolloTron Standard complies with the Directives **2006/42/EC (Machinery directive)** and **2014/30/EU (EMC Directive)**.

The full text of the EU declaration of conformity is included with the product and is kept on file by the manufacturer.s.

RADEMACHER Geräte-Elektronik GmbH
Buschkamp 7
46414 Rhede (Germany)



27. Accessories

A comprehensive range of accessories is available for customising your **RolloTron Standard** to local conditions.

Further information about our accessories is available at the following website:

www.rademacher.de/zubehoer

RADEMACHER Geräte-Elektronik GmbH provides a 36-month warranty for new systems that have been installed in compliance with the installation instructions. All construction faults, material defects and manufacturing defects are covered by the warranty.

Your statutory warranty claims shall remain unaffected by this warranty.

The following are not covered by the warranty:

- ◆ Incorrect fitting or installation
- ◆ Non-observance of the installation and operating instructions
- ◆ Improper operation or wear and tear
- ◆ External influences, such as impacts, knocks or weathering
- ◆ Repairs and modifications by third party, unauthorised persons
- ◆ Use of unsuitable accessories
- ◆ Damage caused by unacceptable excess voltages (e.g. lightning)
- ◆ Operational malfunctions caused by radio frequency overlapping and other such radio interference

For the warranty to be applicable, the new device must have been purchased through one of our approved specialist retailers. Proof of this can be provided by pre-senting a copy of the bill.

RADEMACHER shall remedy any defects, which occur within the warranty period free of charge either by repair or by replacement of the affected parts or by supply of a new replacement unit or one to the same value. There is no general extension of the original warranty period by delivery of a replacement or by repair as per the terms of the warranty.

RADEMACHER

Geräte-Elektronik GmbH
Buschkamp 7
46414 Rhede (Germany)
info@rademacher.de
www.rademacher.de

Service:

Hotline 01807 933-171*

Fax +49 2872 933-253
service@rademacher.de

* 30 seconds free of charge, subsequently 14 cents / minute from German fixed line networks and max. 42 cents / minute from German cellular networks.